



Clean Water Act Section 401 Water Quality Certification Application

Please refer to the "Clean Water Act Section 401 Water Quality Certification Application Guidance" document for assistance with completing this application.

A. Pre-Filing Meeting	
Please provide the date that a pre-filing meeting was requested from Nevada Division of Environmental Protection (NDEP) Bureau of Water Quality Planning (BWQP).	2/19/2025
<i>Note: If a pre-filing meeting has not been requested, please schedule a pre-filing meeting with NDEP BWQP.</i>	

B. Contact Information	
Project Proponent Information	
Company Name: Sierra Pacific Power Co. dba NV Energy	Address: PO Box 10100-S4B15
Applicant Name: Will Morgan	City: Reno
Phone: (775) 834-3362 Fax:	State: Nevada
Email: William.Morgan@nvenergy.com	Zip Code: 89520
Agent Information	
Company Name: Ascent Environmental, Inc.	Address: 128 Market Street, Suite 3E
Agent Name: Josh Eastes	City: Stateline
Phone: (916) 980-9683 Fax:	State: Nevada
Email: Josh.Eastes@ascent.inc	Zip Code: 89449

C. Project General Information	
Project Location	
Project/Site Name: Curry Street 1280 Underground	Name of receiving waterbody: Mapped NWI Freshwater Emergent Wetland, PEM1B (Feature 1); mapped NWI Riverine Feature, R4SBA (Feature 2). These drain to Clear Creek, then the Carson River, and ultimately Lahontan Reservoir.
Address: 136 Jeffrey Pine Lane	Type of waterbody present at project location (<i>select all that apply</i>):
City: Carson City	<input type="checkbox"/> Perennial River or Stream
County: Douglas	<input checked="" type="checkbox"/> Intermittent River or Stream
State: Nevada	<input type="checkbox"/> Ephemeral River or Stream
Zip Code: 89705	<input type="checkbox"/> Lake/Pond/Reservoir
Latitude (UTM or Dec/Deg): 39.112336°	<input checked="" type="checkbox"/> Wetland
	<input type="checkbox"/> Other: _____
	Longitude (UTM or Dec/Deg): -119.849232°

Township: 14N	Range: 19E	Section: 4	¼ Section: L2
Project Details			
Project purpose:		NV Energy is focused on grid hardening efforts in areas that are most at risk of wildfire; undergrounding critical lines is important to that process.	
Describe current site conditions: Attachments can include, but are not limited to, relevant site data, photographs that represent current site conditions, or other relevant documentation.		There are two areas where the project proposes undergrounding of powerlines in mapped NWI aquatic resources. These resources include a Palustrine Emergent Wetland located along Jeffrey Pine Road (Feature 1) and a riverine feature culverted under Jeffrey Pine Road (Feature 2). Jeffrey Pine Road was constructed (aerial imagery indicates between 2006 and 2007) adjacent to and potentially in Feature 1. Grading was performed to construct the road, and a drainage ditch was constructed on the uphill (northwest) side of the road to intercept runoff flowing down toward the road. This ditch was likely excavated in an upland area but is currently populated with plant species typically growing in wetter areas.	
Describe the proposed activity including methodology of each project element:		The 2-foot-wide trench alignment for the underground conduit would be excavated to 4 (for secondary conduit) or 5 (for primary conduit) feet in depth. The conduit would be placed a minimum of 2 (for secondary conduit) or 6 (for primary conduit) inches from the trench walls. The trench would be backfilled with sand and either native material (on private lands) or aggregate base (on existing paved roads) to grade. Tracked mini and full-size excavators will be used for trenching activities. Pickup or dump trucks would be used to remove excavated materials from the project site. The existing culvert associated with Feature 2 would be left in place and no equipment would enter the riverine wetland. Hand digging around the culvert would occur to support undergrounding conduit under the culvert. Staging materials would occur on private lands north of Jeffrey Pine Road (outside of mapped wetland features) and on the paved surface of Jeffrey Pine Road. Excess materials from trenching would be staged on Jeffrey Pine Road and removed from the site by truck to prevent sediment from entering wetland features.	
Estimate the nature, specific location, and number of discharge(s) expected to be authorized by the proposed activity:		Trenching and hand-digging activities would potentially disturb 3,150 ft ² of soil within Feature 1 (emergent wetland) and 180 ft ² of soil around Feature 2 (riverine); there would not be disturbance within Feature 2. Disturbances/discharges from trenching and hand-digging activities would be limited to construction only and would not continue after construction is completed. Disturbed areas, including the trench, would be returned to pre-project conditions after construction.	
Provide the date(s) on which the proposed activity is planned to begin and end and the approximate date(s) when any discharge(s) may commence:		Construction is planned for initiation in May or June 2025; construction is anticipated to be completed in 3-4 months (August or September 2025).	

Provide a list of the federal permit(s) or license(s) required to conduct the activity which may result in a discharge into regulated waters (see mandatory attachments):	Non-Noticing Nationwide Permit 57. This project assumes coverage under Nationwide Permit 57 and meets the thresholds to be non-noticing (e.g., impacts less than 1/10 acres).	
Provide a list of all other federal, state, interstate, tribal, territorial, or local agency authorizations required for the proposed activity and the current status of each authorization:	N/A; no Working in Waters permit is required for this project, as determined in consultation with the NDEP Bureau of Water Pollution Control.	
Total area of impact to regulated waterbodies (acres):	0.07644628 acres. This estimate assumes that Features 1 and 2 are jurisdictional Waters of the U.S.; no delineation was performed to confirm the jurisdictional status or extent of the mapped NWI wetlands. Acreage calculations were based on a conservative 9-foot width for the length of project components through mapped NWI features (370 linear feet).	
Total distance of impact to regulated waterbodies (linear feet):	Assuming Features 1 and 2 are jurisdictional Waters of the U.S., impacts would occur <i>within</i> regulated waterbodies.	
Amount excavation and/or fill discharged within regulated waters (acres, linear feet, and cubic yards):	Temporary: 0.07644628 acres, 370 linear feet, 137 cubic yards	Permanent: N/A
	Temporary: N/A	Permanent: N/A
Amount of dredge material discharged within regulated waters (acres, linear feet, and cubic yards):		
Describe the reason(s) why avoidance of temporary fill in regulated waters is not practicable (if applicable):	Alignment of the underground conduit was not possible outside of the mapped NWI wetlands (e.g., on the western side of Jeffrey Pine Lane) due to constructability.	
Describe the Best Management Practices (BMPs) to be implemented to avoid and/or minimize impacts to regulated waters: Examples include sediment and erosion control measures, habitat preservation, flow diversions, dewatering, hazardous materials management, water quality monitoring, equipment or plans to treat, control, or manage discharges, etc.	Silt fences, gravel bag berms, and/or fiber rolls would be placed down gradient from proposed work areas to capture any mobilized sediment. Spill kits would be used to contain non-sediment discharges. Dewatering (if needed) and runoff control plans will be followed to minimize impacts on Features 1 and 2. The dewatering plan is attached. Dewatering will occur only when groundwater is observed seeping into the trench during construction. Construction activities will be halted during periods of precipitation and intermittent flow through the wetland features to prevent disruption to flow regimes and to avoid the need for flow bypasses or other stormwater control measures.	
Describe how the activity has been designed to avoid and/or minimize adverse effects, both temporary and permanent, to regulated waters:	Trenching would be conducted in disturbed areas associated with the construction of Jeffrey Pine Lane, where possible. The culvert associated with Feature 2 will be left in place and no equipment will enter the riverine wetland. A revegetation and reclamation plan is provided and will be followed to restore the area impacted by project activities to pre-construction conditions. Native topsoil will be placed on top of the trenched areas to promote native revegetation.	

Describe any compensatory mitigation planned for this project (if applicable):	This project does not meet the criteria requiring compensatory mitigation because no 404 permit is required. This project assumes coverage under Nationwide Permit 57 and meets the thresholds to be non-noticing. Revegetation and reclamation activities will be enacted to restore impacted areas to pre-construction conditions.
--	--

D. Signature		
Name and Title (Print): Will Morgan, Manager, Transmission & Distribution Projects – Natural Disaster Protection Plan	Phone Number: (775) 834-3362	Date: 3/27/25
 X _____ Signature of Responsible Official		

Mandatory Attachments:

- **Federal Permit or License Application** - A copy of the federal permit or license application and any readily available water quality-related materials that informed the development of the federal license or permit application.
- **Site Map** - A map or diagram of the proposed project site including project boundaries in relation to regulated waters, local streets, roads, and highways.
- **Engineered Drawings** - Engineered drawings are preferred to be submitted at the 70% design level. If only conceptual designs are available at the time of application, plans for construction should be submitted prior to the start of the project. Specific locations of the proposed activities and details of specific work elements planned for the project should be identified (e.g., staging areas, concrete washouts, perimeter controls, water diversions, or other BMPs).

Submit the completed application materials to NDEP (ndep401@ndep.nv.gov) with the appropriate U.S. Army Corps of Engineers Regulatory Office copied on the communication (<http://www.spk.usace.army.mil/Missions/Regulatory/Contacts/Contact-Your-Local-Office/>).



THIS PROJECT IS LOCATED WITHIN A TIER 3 AND TIER 1E FIRE AREA AND A WILDLAND URBAN INTERFACE (WUI) AREA

A PRE CONSTRUCTION MEETING IS REQUIRED ON ALL PROJECTS PLEASE CALL CARSON OPERATIONS AT (775)834-2977 TO SCHEDULE 48 HOURS PRIOR TO CONSTRUCTION.

15' OSHA 1910.269 WORKING CLEARANCE FOR UN-QUALIFIED ELECTRICAL WORKERS MUST BE MET DURING CONSTRUCTION OF THE PROJECT.

NOTE: CONTRACTOR IS RESPONSIBLE FOR ADHERENCE TO NVE GAS AND ELECTRIC STANDARDS. CONSTRUCTION STANDARDS CAN BE FOUND ON-LINE AT THE FOLLOWING WEB SITE: www.nvenergy.com/business/building-and-new-construction-north

CONTRACTOR TO FURNISH AND/OR INSTALL:

3 - LOAD BREAK METAL JUNCTION ENCLOSURE PADS 10 STK. #24-0721.

PROPOSED APPROX. 3298 FT. 3" PVC PRIMARY CONDUIT.

APPLICANT IS RESPONSIBLE FOR MANDRELLING CONDUIT AND INSTALLING A PULL LINE THAT MEETS OR EXCEEDS THE FOLLOWING REQUIREMENTS:

- THE PULL LINE WILL BE OF A FLAT DESIGN
- SHALL HAVE A MINIMUM BREAKING STRENGTH OF 400 LBS.
- WILL HAVE SEQUENTIAL FOOTAGE MARKINGS
- EXAMPLES OF PULL LINES THAT MEET THESE REQUIREMENTS (NVE. STK.#95-7305)
- NEPTCO "MULE TAPE" (W/4000P)
- CONDUK INTERNATIONAL (08098203)
- SEE NVE VOLUME 17, SECTION 4-CD0001U.

15" DIAMETER, FLAT CONDUIT MARKERS, RED IN COLOR AT DESIGNATED LOCATIONS SHOWN ON DRAWINGS. MARKER WILL BE A 3M MODEL 1251 (NVE STK.#25-3125), BURIED A MAXIMUM OF 4 1/2" BELOW FINISH GRADE.

ALL SECONDARY RISER CONDUIT TO BE 3" MINIMUM.

ALL CONDUIT TO BE A MINIMUM DB120 PVC GRAY BELOW GROUND.

(ABOVE GROUND RISER CONDUIT TO INCLUDE: SCH 80 SWEEP, 10' OF SCH 80, 2 - 10' SECTIONS OF SCH 40 AND BOLT-ON WEATHER HEAD. SWEEP AND RISER MATERIAL MUST BE OF LIKE KIND. STEEL OR PVC)

NOTE: ALL CONDUIT INSTALLATIONS BENEATH FOUNDATION AND SLABS TO BE RIGID STEEL OR CONCRETE ENCASED PER NVE STDS. CD0003U.

APPROX. LF. (20' MAX.) OF CABLE TRENCH (PRECASTED PREFERRED CONSTRUCTION) WITH PEDESTRIAN OR H20 RATED COVER, CABLE SUPPORT RACKS, ARMS, AND MOUNTING HARDWARE.

THE FOLLOWING APPROVALS OF FINAL CABLE TRENCH DESIGN WILL BE REQUIRED PRIOR TO INSTALLATION:

PRECASTED, (PREFERRED) A SKETCH OR WORKSHEET OF PROPOSED DESIGN WILL BE SUBMITTED TO JENSEN PRECAST. FAX (775) 359-1039. CONTACT: ANTHONY BOSCO 352-6303, WHERE A FINAL DRAWING WILL BE PROVIDED AND APPROVED BY NVE AND CONTRACTOR. POURED IN PLACE, (NON-PREFERRED) A SKETCH OR WORKSHEET WILL BE SUPPLIED TO THE INSPECTION GROUP, (RENO), FAX (775) 834-7048, CONTACT: MIKE HILLERY 834-7114 OR PLANNER (DISTRICT OFFICE) FOR REVIEW AND APPROVAL.

REFERENCE G1001U FOR COMPLETE SPECIFICATIONS OF CABLE TRENCH CONSTRUCTION.

ALL TRENCHING AND BACKFILL PER APPLICABLE NVE. STDS. TE0001, TE0003, TE0004 AND TE0020.

ALL STAKING REQUIREMENTS PER NVE. STD. G1001U/G/W AND G1002U.

ALL STREET CUT PERMITS AND PAVEMENT CUTTING AND REPLACEMENT AS REQUIRED.

INSTALLATION OF U/G ELECTRIC FACILITIES IN RESIDENTIAL SUBDIVISIONS PER NVE. STD. RU0005U.

RETAINING WALL REQUIREMENTS PER NVE. STD. TE0040U.

OVERHEAD ELECTRIC, APPLICANT OWNED, SERVICE POLE PER NVE. STD. CP0001M.

PRIMARY RISER RISER MATERIAL C/O 3" MINIMUM DB-120 SWEEP, 10' OF 3" SCHEDULE 80 CONDUIT AND 30' OF SCHEDULE 40 CONDUIT. STAND-OFF BRACKETS AND LAG SCREWS BY NVE. (NVE TO INSTALL 30' OF SCHEDULE 40 CONDUIT ONLY.) TRAFFIC AREAS SHALL BE GALVANIZED RIGID STEEL FOR FIRST 10' OF RISER. SWEEP AND RISER MATERIAL MUST BE OF LIKE KIND. (STEEL OR PVC)

8" x 5/8" GROUND RODS AT SWITCH, TRANSFORMER AND JUNCTION ENCLOSURE LOCATIONS.

BEFORE INSTALLATION OF THE UTILITY FACILITIES AND IF NO PUBLIC UTILITY EASEMENTS EXIST, THE OWNER OF RECORD SHALL SIGN APPROPRIATE EASEMENT DOCUMENTS.

ALL SERVICE CONDUITS TO BE STUBBED 10' MINIMUM FROM TRANSFORMER PADS AND SECONDARY BOXES AT THE SAME TIME AS MAIN LINE INSTALLED PER NVE STDS VOLUME 17. (TE0020U)

GENERAL COMMENTS:

CALL NVE INSPECTION REQUEST LINE (775) 48 HOURS PRIOR TO START OF ALL OVERHEAD OR UNDERGROUND CONSTRUCTION.

METER PANELS ARE TO BE LABELED IN ACCORDANCE WITH NVE STD. GM0001M SEC. 5.3

VAULTS, TRANSFORMERS AND SECONDARY BOXES WILL HAVE MINIMUM 3' FLAT AND CLEAR ON ALL FOUR SIDES, 10' CLEAR IN FRONT OF TRANSFORMERS.

PADMOUNT EQUIPMENT MUST MEET REQUIRED LOCATIONS/CLEARANCES PER NVE. STD. PE0010U

THREE PHASE TRANSFORMERS AND EQUIPMENT (SWITCHES) WILL HAVE A 10 FOOT LONG BY THE PAD WIDTH, FLAT LEVEL SURFACE IN FRONT OF THE OPENING FOR OPERATING THE SWITCH OR TRANSFORMER BY NVE PERSONAL. SUITABLE MATERIALS ARE CONCRETE, ASPHALT OR PAVING BRICKS. THE CLEAR SURFACE WILL BE REVIEWED BY THE PLANNER AND INSPECTOR PRIOR TO ENERGIZATION OF EQUIPMENT. PER NVE. STD. PE0010U

EQUIPMENT BARRIER POSTS MAY BE REQUIRED PER NVE. STD. PE0009U.

RETAINING WALLS MAY BE REQUIRED FOR ANY SLOPES GREATER THAN 15% PER NVE. STD. TE0040U.

ALL SECONDARY BOXES AND PRIMARY VAULTS SHALL BE TO FINISH GRADE.

ALL MATERIAL SHALL BE ON THE JOB SITE PRIOR TO THE START OF ANY WORK BY NVE.

REFER TO NVE. STDS. C10001M or US0001M or OS0001U FOR FURTHER CLARIFICATION OF DETAILS.

COMPACTION TESTS REQUIRED PER NVE. STD. SUB01X.

NO TREE SHALL BE PLANTED UNDER OR ADJACENT TO ENERGIZED POWER LINES WHICH, AT MATURITY, SHALL GROW WITHIN 10 FEET OF THE ENERGIZED CONDUCTORS. NOR SHALL ANY PERMANENT STRUCTURE, FENCE, SHRUB OR TREE BE PLANTED CLOSER THAN 10 FEET IN FRONT AND 3 FEET FROM ALL OTHER SIDES OF A PAD MOUNTED TRANSFORMER.

THESE DRAWINGS ARE BASED ON CIVIL PLANS DATED: 2/10/2023

NOTE: DEVELOPER IS RESPONSIBLE FOR ADHERENCE TO NV ENERGY GAS AND ELECTRIC STANDARDS. CONSTRUCTION STANDARDS CAN BE FOUND ON-LINE AT THE FOLLOWING WEB SITE: <http://www.nvenergy.com/account-services/building-and-new-construction>

APPLICANT SHALL BE RESPONSIBLE FOR PROTECTING GAS VALVES, ELECTRIC CABLES, DUCTS, AND OTHER STRUCTURES FROM SUPERIMPOSED LOADING CREATED BY CONSTRUCTION EQUIPMENT OR OTHERWISE. APPLICANT SHALL REPAIR OR PAY FOR ANY DAMAGE DONE TO ABOVE EQUIPMENT TO MEET NVE'S INSPECTOR APPROVAL. NVE STD. VOL. 17 RU0005U

THIS MAP ILLUSTRATES DATA COLLECTED FROM VARIOUS SOURCES AND MAY NOT REPRESENT A SURVEY OF THE PREMISES. NO RESPONSIBILITY IS ASSUMED AS TO THE SUFFICIENCY OR ACCURACY OF THE DATA DISPLAYED HEREON.

ALL WORK SHALL BE ACCOMPLISHED IN STRICT ACCORDANCE WITH THE SPECIFICATIONS SET FORTH IN THE ELECTRIC DISTRIBUTION GUIDE, VOL. 17 AS CURRENTLY ADOPTED BY NVE. THE CONTRACTOR SHALL SECURE COPIES OF THE AFOREMENTIONED CONSTRUCTION SPECIFICATIONS ON HIS OR HER OWN BEHALF.

USE CAUTION! PRIOR TO EXCAVATION, CHECK TO ENSURE ADDITIONAL DEPTH IS NOT REQUIRED TO ACCOMMODATE GAS AND/OR WATER FACILITIES.

SYMBOLS ARE NOT TO SCALE AND DO NOT NECESSARILY REPRESENT ACTUAL LOCATIONS OF FACILITIES.

DO NOT OPEN NV ENERGY EQUIPMENT. NV ENERGY EQUIPMENT TO BE OPENED BY QUALIFIED NV ENERGY EMPLOYEES ONLY.

NV ENERGY APPROVED PLANS SHALL BE ON SITE DURING CONSTRUCTION AND INSPECTION

NOTE: ALL RESIDENTIAL SERVICE WIRE IS 2/0TX IN 1-3" CONDUIT UNLESS OTHERWISE NOTED.

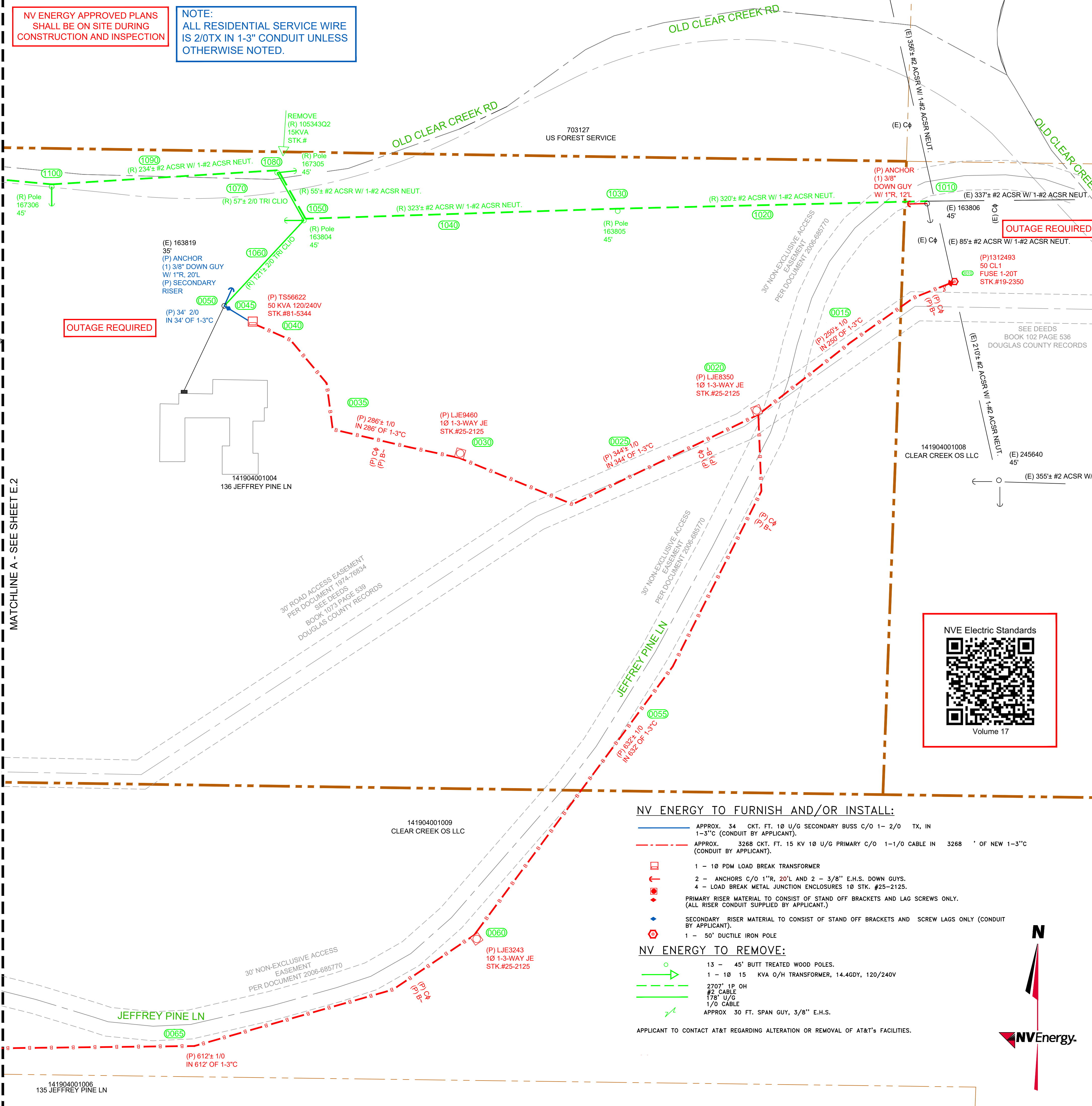

MATCHLINE A - SEE SHEET E.2



NV ENERGY TO FURNISH AND/OR INSTALL:

- APPROX. 34 CKT. FT. 10 U/G SECONDARY BUSS C/O 1- 2/0 TX, IN 1-3" CONDUIT BY APPLICANT.
- APPROX. 3268 CKT. FT. 15 KV 10 U/G PRIMARY C/O 1-1/0 CABLE IN 3268' OF NEW 1-3" CONDUIT BY APPLICANT.
- 1 - 10 PDM LOAD BREAK TRANSFORMER
- 2 - ANCHORS C/O 1"R, 20'L AND 2 - 3/8" E.H.S. DOWN GUYS.
- 4 - LOAD BREAK METAL JUNCTION ENCLOSURES 10 STK. #25-2125.
- PRIMARY RISER MATERIAL TO CONSIST OF STAND OFF BRACKETS AND LAG SCREWS ONLY. (ALL RISER CONDUIT SUPPLIED BY APPLICANT.)
- SECONDARY RISER MATERIAL TO CONSIST OF STAND OFF BRACKETS AND SCREW LAGS ONLY (CONDUIT BY APPLICANT).
- 1 - 50' DUCTILE IRON POLE

NV ENERGY TO REMOVE:

- 13 - 45' BUTT TREATED WOOD POLES.
- 1 - 10 15 KVA O/H TRANSFORMER, 14.4GDY, 120/240V
- 2707' 1P OH #2 CABLE
- 178' U/G 1/0 CABLE
- APPROX 30 FT. SPAN GUY, 3/8" E.H.S.

APPLICANT TO CONTACT AT&T REGARDING ALTERATION OR REMOVAL OF AT&T'S FACILITIES.

DRAWING	DESIGNED BY	DATE
BASE	JLE	
ELECTRIC	JLE	7/22/2022
GAS		

REVIEWED BY:			
Utility Designer	Engineer	Design Administrator	Design Facilitator
<i>JLE</i>		<i>JB</i>	

NO.	REVISION	DESCRIPTIONS	DATE	DI
1				
2				
3				
4				
5				
6				
7				

AVOID HITTING OVERHEAD POWER LINES. IT'S COSTLY.

CALL BEFORE YOU DIG OVERHEAD

Call before you Dig

Call 1-702-227-2929

NVEnergy

P.O. Box 10100
R77CSE
Reno, NV. 89520-0024

NV ENERGY CONTACT INFORMATION:

COORDINATOR: EDMISTON, JILL
OFFICE: # (775)527-3100
CELL: # (775) 527-3100
FAX: #
EMAIL: Jill.Edmiston@nvenergy.com
DESIGNER: EDMISTON, JILL
INSPECTION HOTLINE: # 888/999-1556

CUSTOMER CONTACT INFORMATION:

CUSTOMER: _____
ATTENTION: _____
PHONE: # _____
FAX: # _____
EMAIL: _____
CUST REP: # WILLIAM MORGAN
PHONE: # 775-530-0683
EMAIL: _____

TOWNSHIP-RANGE-SECTION	APN#
1519-33	141904001001, 141904001008, 141904001009, 141904001012

SOURCE INFORMATION:

1280 LINE
12.5KV NORM OUT OF
CURRY ST SUB

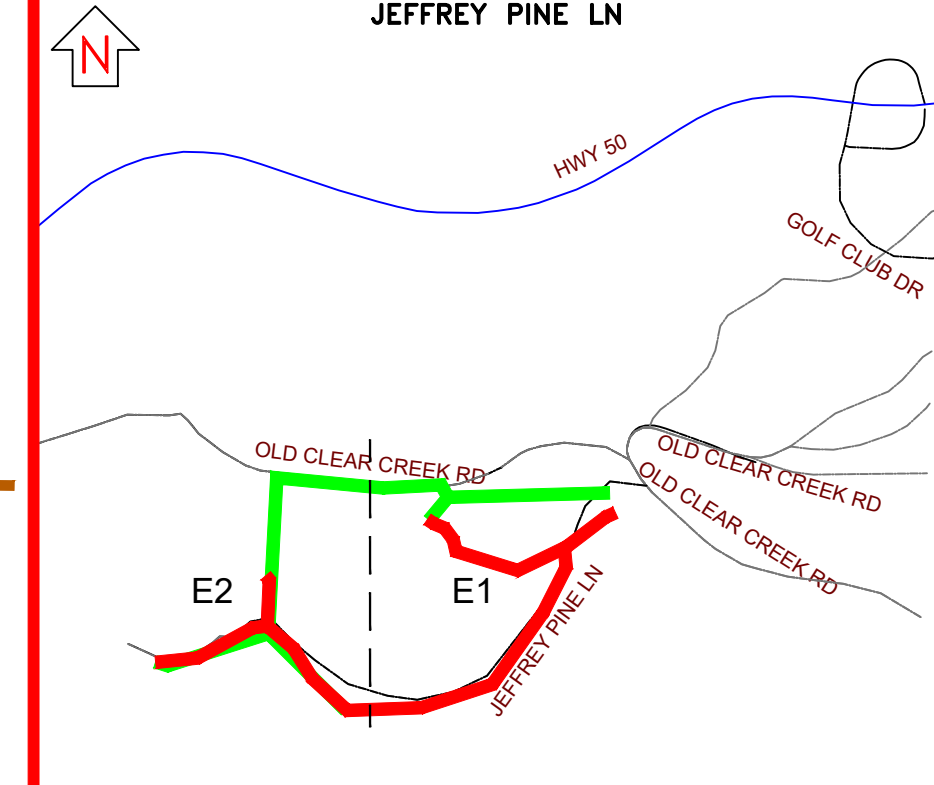

E-UG PILOT-CURRY 1280 TIER 3-NDPP

EXHIBIT "A" APPLICANT INSTALLED CONDUIT ELECTRIC DESIGN	GAS#: AUD#: 3009729668	ELE#: 3009729668
SCALE: 1"=50'		
SHEET#: E1 of E2		

DRAWING	DESIGNED BY	DATE
ELECTRIC	JLE	7/22/2022

REVIEWED BY:			
Utility Designer	Engineer	Design Administrator	Design Facilitator
<i>JLC</i>		<i>JB</i>	

NO.	REVISION	DESCRIPTIONS	DATE	DI
1				
2				
3				
4				
5				
6				
7				

AVOID HITTING OVERHEAD POWER LINES. IT'S COSTLY.

Call 811

CALL BEFORE YOU DIG

Call before you Dig

Avoid hitting underground utilities. It's costly.

CALL 1-702-227-2929

NVEnergy

P.O. Box 10100
R77CSE
Reno, NV. 89520-0024

NV ENERGY CONTACT INFORMATION:

COORDINATOR: EDMISTON, JILL
OFFICE: # (775)527-3100
CELL: # (775) 527-3100
FAX: #
EMAIL: Jill.Edmiston@nvergy.com
DESIGNER: EDMISTON, JILL
INSPECTION HOTLINE: # 888/999-1556

CUSTOMER CONTACT INFORMATION:

CUSTOMER: _____
ATTENTION: _____
PHONE: # _____
FAX: # _____
EMAIL: _____
CUST REP: # WILLIAM MORGAN
PHONE: # 775-530-0683
EMAIL: _____

TOWNSHIP-RANGE-SECTION 1519-33	APN# 141904001001, 141904001004, 141904001008, 141904001009, 141904001012
-----------------------------------	--

SOURCE INFORMATION:

1280 LINE
12.5KV NORM OUT OF
CURRY ST SUB

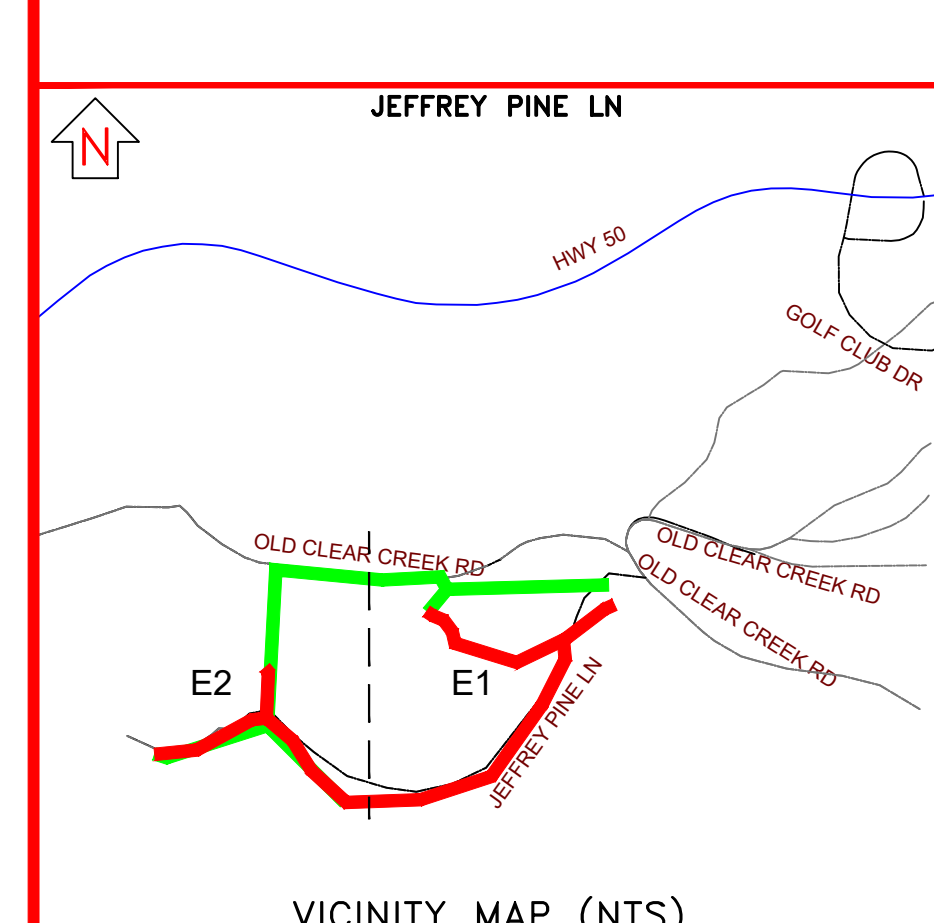

E-UG PILOT-CURRY 1280 TIER 3-NDPP

EXHIBIT "A" APPLICANT INSTALLED CONDUIT	GAS#: AUID#: 3009729648	ELE#: 3009729648
ELECTRIC DESIGN		
SCALE: 1"=50'		
SHEET#: E2 of E2		

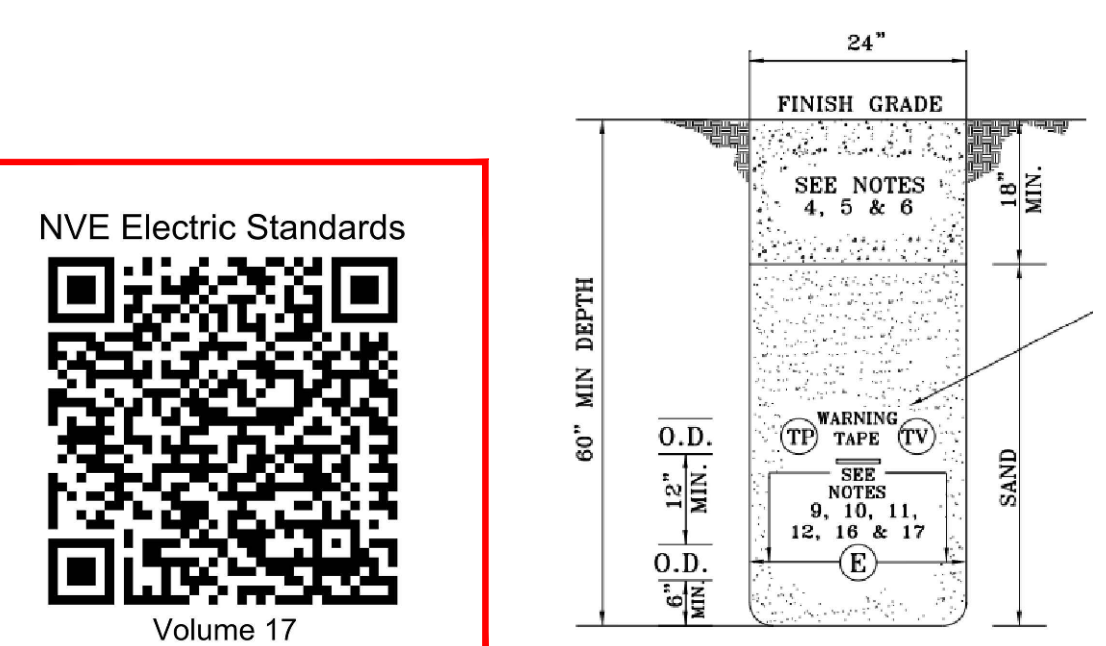
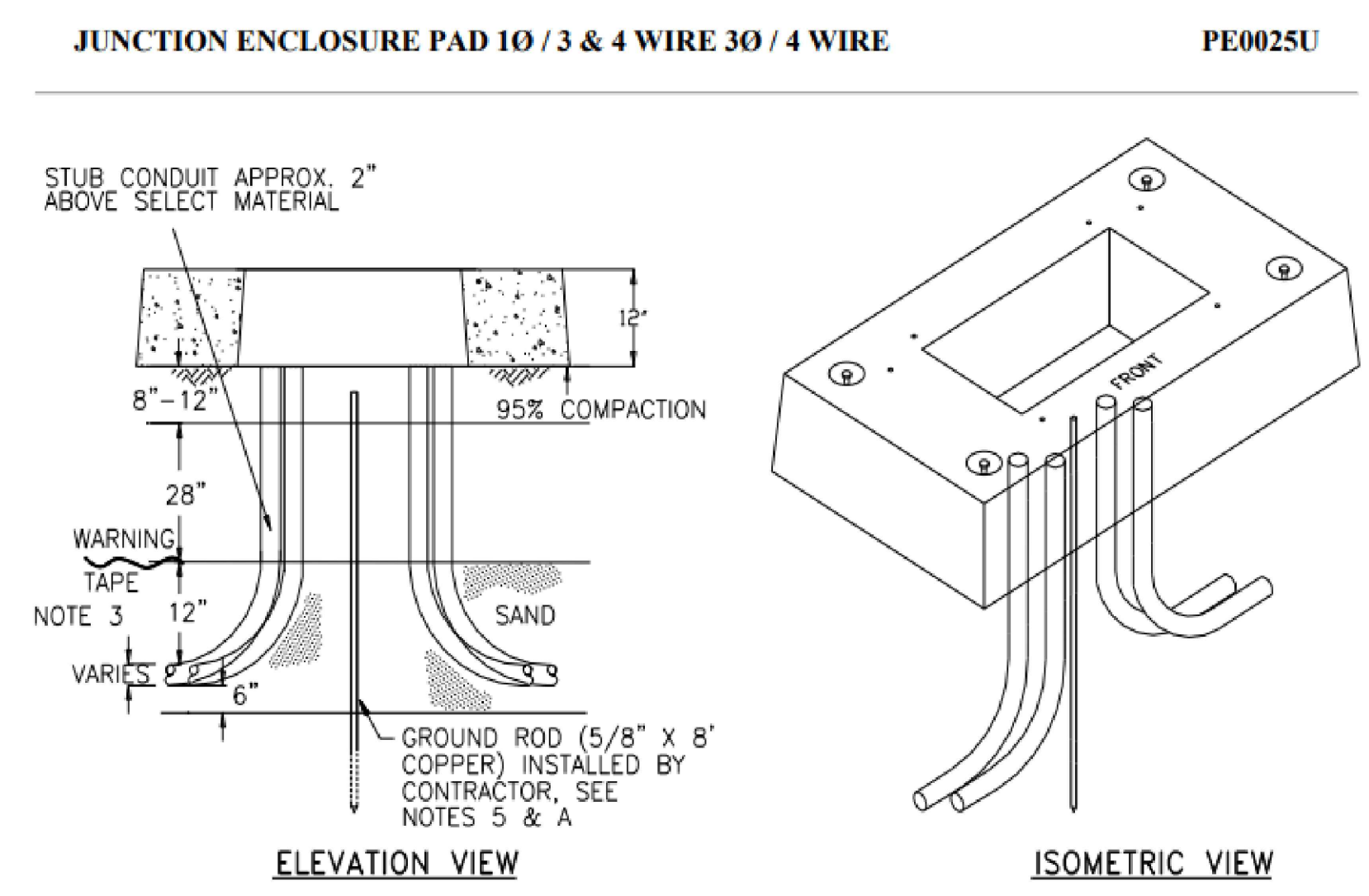
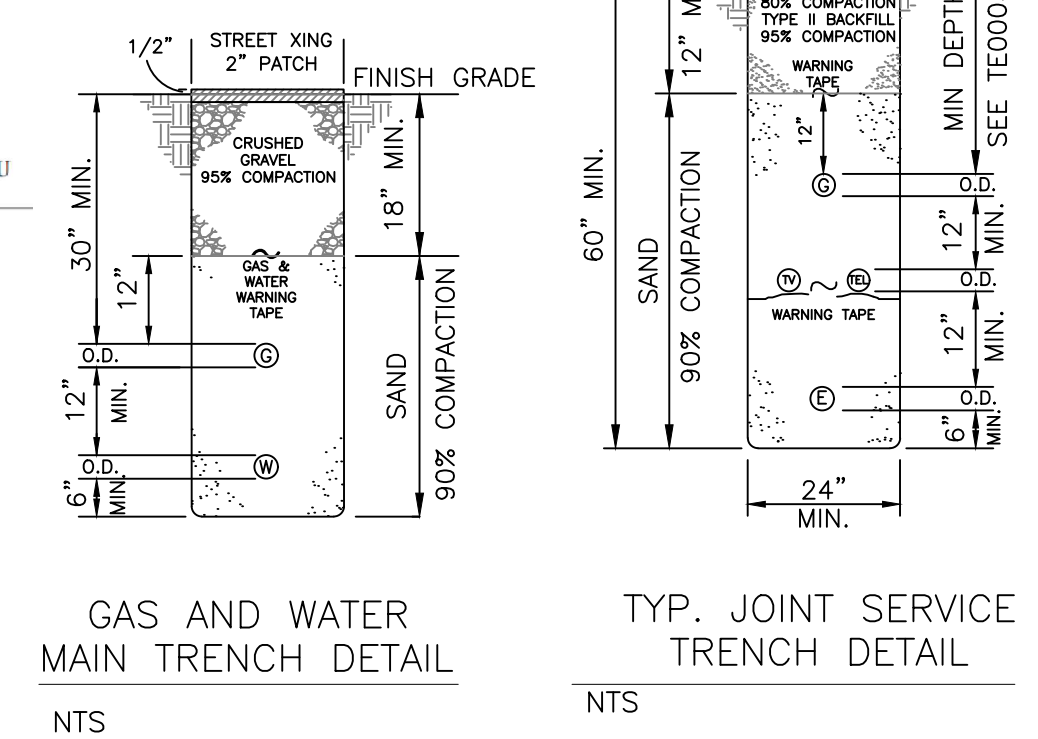
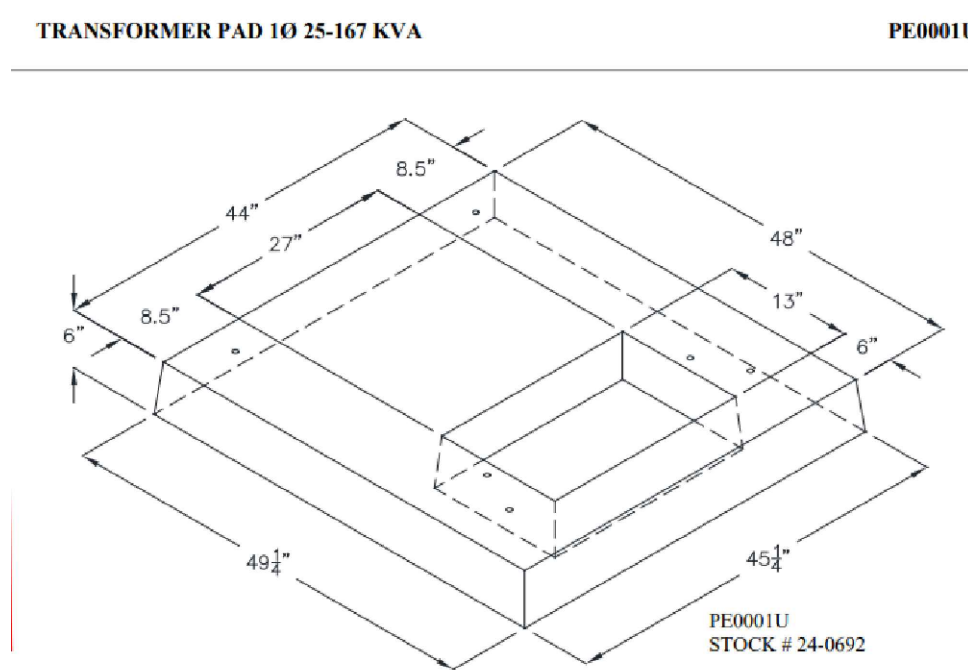
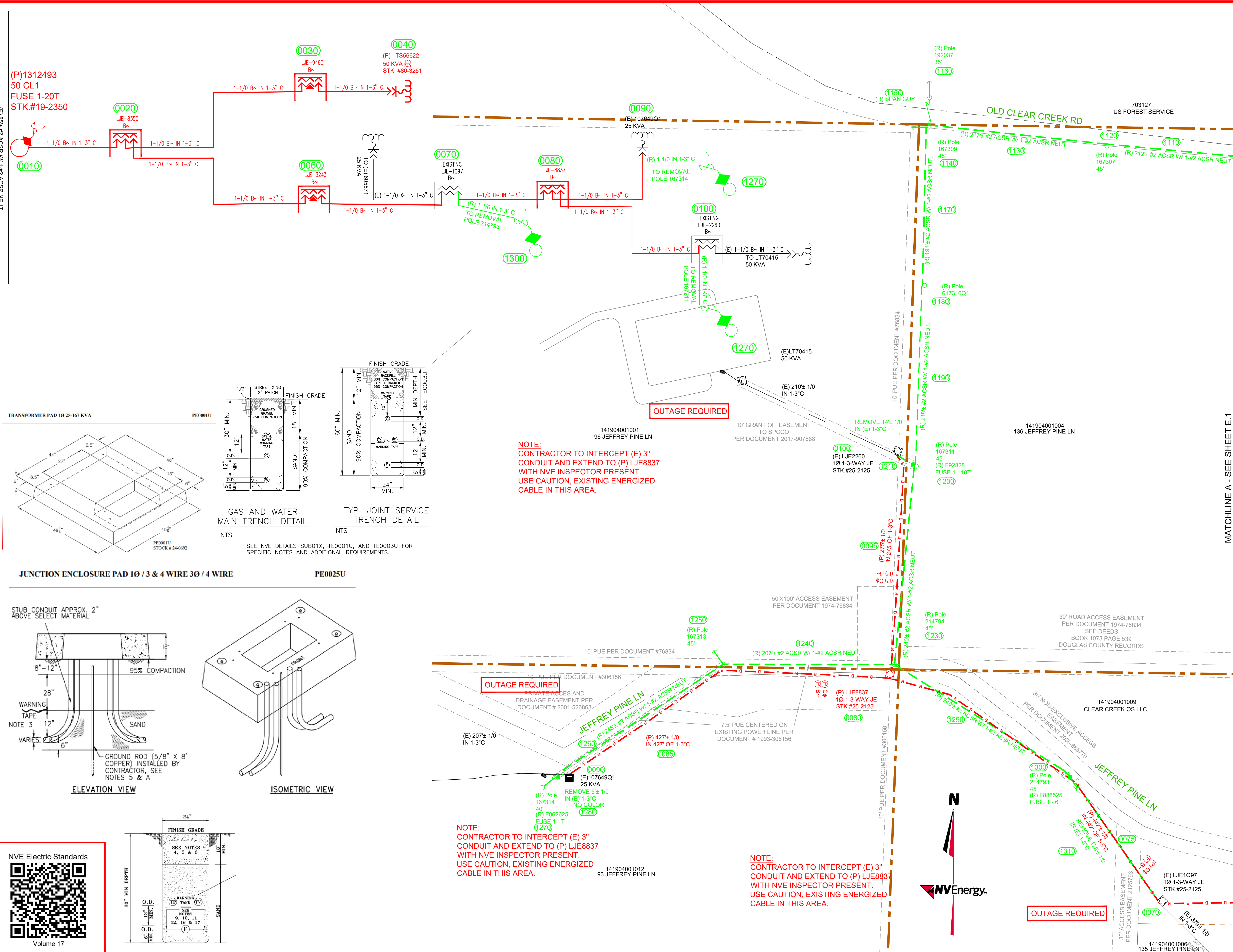

NOTE:
CONTRACTOR TO INTERCEPT (E) 3" CONDUIT AND EXTEND TO (P) LJE8837 WITH NVE INSPECTOR PRESENT. USE CAUTION, EXISTING ENERGIZED CABLE IN THIS AREA.

OUTAGE REQUIRED

NOTE:
CONTRACTOR TO INTERCEPT (E) 3" CONDUIT AND EXTEND TO (P) LJE8837 WITH NVE INSPECTOR PRESENT. USE CAUTION, EXISTING ENERGIZED CABLE IN THIS AREA.

NOTE:
CONTRACTOR TO INTERCEPT (E) 3" CONDUIT AND EXTEND TO (P) LJE8837 WITH NVE INSPECTOR PRESENT. USE CAUTION, EXISTING ENERGIZED CABLE IN THIS AREA.



MATCHLINE A - SEE SHEET E.1

Nationwide Permit 57
Electric Utility Line and Telecommunications Activities
Effective Date: March 15, 2021 / Expiration Date: March 14, 2026
Authorities: Sections 10 and 404

Activities required for the construction, maintenance, repair, and removal of electric utility lines, telecommunication lines, and associated facilities in waters of the United States, provided the activity does not result in the loss of greater than 1/2-acre of waters of the United States for each single and complete project.

Electric utility lines and telecommunication lines: This NWP authorizes discharges of dredged or fill material into waters of the United States and structures or work in navigable waters for crossings of those waters associated with the construction, maintenance, or repair of electric utility lines and telecommunication lines. There must be no change in pre-construction contours of waters of the United States. An “electric utility line and telecommunication line” is defined as any cable, line, fiber optic line, or wire for the transmission for any purpose of electrical energy, telephone, and telegraph messages, and internet, radio, and television communication.

Material resulting from trench excavation may be temporarily sidecast into waters of the United States for no more than three months, provided the material is not placed in such a manner that it is dispersed by currents or other forces. The district engineer may extend the period of temporary side casting for no more than a total of 180 days, where appropriate. In wetlands, the top 6 to 12 inches of the trench should normally be backfilled with topsoil from the trench. The trench cannot be constructed or backfilled in such a manner as to drain waters of the United States (e.g., backfilling with extensive gravel layers, creating a french drain effect). Any exposed slopes and stream banks must be stabilized immediately upon completion of the electric utility line or telecommunication line crossing of each waterbody.

Electric utility line and telecommunications substations: This NWP authorizes the construction, maintenance, or expansion of substation facilities associated with an electric utility line or telecommunication line in non-tidal waters of the United States, provided the activity, in combination with all other activities included in one single and complete project, does not result in the loss of greater than 1/2-acre of waters of the United States. This NWP does not authorize discharges of dredged or fill material into non-tidal wetlands adjacent to tidal waters of the United States to construct, maintain, or expand substation facilities.

Foundations for overhead electric utility line or telecommunication line towers, poles, and anchors: This NWP authorizes the construction or maintenance of foundations for overhead electric utility line or telecommunication line towers, poles, and anchors in all waters of the United States, provided the foundations are the minimum size necessary and separate footings for each tower leg (rather than a larger single pad) are used where feasible.

Access roads: This NWP authorizes the construction of access roads for the construction and maintenance of electric utility lines or telecommunication lines, including overhead lines and substations, in non-tidal waters of the United States, provided the activity, in combination with all other activities included in one single and complete project, does not cause the loss of greater than 1/2-acre of non-tidal waters of the United States. This NWP does not authorize discharges of dredged or fill material into non-tidal wetlands adjacent to tidal waters for access roads. Access roads must be the minimum width necessary (see Note 2, below). Access roads must be constructed so that the length of the road minimizes any adverse effects on waters of the United States and must be as near as possible to pre-construction contours and elevations (e.g., at grade corduroy roads or geotextile/gravel roads). Access roads constructed above pre-construction contours and elevations in waters of the United States must be properly bridged or culverted to maintain surface flows.

This NWP may authorize electric utility lines or telecommunication lines in or affecting navigable waters of the United States even if there is no associated discharge of dredged or fill material (see 33 CFR part 322). Electric utility lines or telecommunication lines constructed over section 10 waters and electric utility lines or telecommunication lines that are routed in or under section 10 waters without a discharge of dredged or fill material require a section 10 permit.

This NWP authorizes, to the extent that Department of the Army authorization is required, temporary structures, fills, and work necessary for the remediation of inadvertent returns of drilling fluids to waters of the United States through sub-soil fissures or fractures that might occur during horizontal directional drilling activities conducted for the purpose of installing or replacing electric utility lines or telecommunication lines. These remediation activities must be done as soon as practicable, to restore the affected waterbody. District engineers may add special conditions to this NWP to require a remediation plan for addressing inadvertent returns of drilling fluids to waters of the United States during horizontal directional drilling activities conducted for the purpose of installing or replacing electric utility lines or telecommunication lines.

This NWP also authorizes temporary structures, fills, and work, including the use of temporary mats, necessary to conduct the electric utility line activity. Appropriate measures must be taken to maintain normal downstream flows and minimize flooding to the maximum extent practicable, when temporary structures, work, and discharges of dredged or fill material, including cofferdams, are necessary for construction activities, access fills, or dewatering of construction sites. Temporary fills must consist of materials, and be placed in a manner, that will not be eroded by expected high flows. After construction, temporary fills must be removed in their entirety and the affected areas returned to pre-construction elevations. The areas affected by temporary fills must be revegetated, as appropriate.

Notification: The permittee must submit a pre-construction notification to the district engineer prior to commencing the activity if: (1) a section 10 permit is required; or (2)

the discharge will result in the loss of greater than 1/10-acre of waters of the United States. (See general condition 32.) (Authorities: Sections 10 and 404)

Note 1: Where the electric utility line is constructed, installed, or maintained in navigable waters of the United States (i.e., section 10 waters) within the coastal United States, the Great Lakes, and United States territories, a copy of the NWP verification will be sent by the Corps to the National Oceanic and Atmospheric Administration (NOAA), National Ocean Service (NOS), for charting the electric utility line to protect navigation.

Note 2: For electric utility line or telecommunications activities crossing a single waterbody more than one time at separate and distant locations, or multiple waterbodies at separate and distant locations, each crossing is considered a single and complete project for purposes of NWP authorization. Electric utility line and telecommunications activities must comply with 33 CFR 330.6(d).

Note 3: Electric utility lines or telecommunication lines consisting of aerial electric power transmission lines crossing navigable waters of the United States (which are defined at 33 CFR part 329) must comply with the applicable minimum clearances specified in 33 CFR 322.5(i).

Note 4: Access roads used for both construction and maintenance may be authorized, provided they meet the terms and conditions of this NWP. Access roads used solely for construction of the electric utility line or telecommunication line must be removed upon completion of the work, in accordance with the requirements for temporary fills.

Note 5: This NWP authorizes electric utility line and telecommunication line maintenance and repair activities that do not qualify for the Clean Water Act section 404(f) exemption for maintenance of currently serviceable fills or fill structures.

Note 6: For overhead electric utility lines and telecommunication lines authorized by this NWP, a copy of the PCN and NWP verification will be provided by the Corps to the Department of Defense Siting Clearinghouse, which will evaluate potential effects on military activities.

Note 7: For activities that require pre-construction notification, the PCN must include any other NWP(s), regional general permit(s), or individual permit(s) used or intended to be used to authorize any part of the proposed project or any related activity, including other separate and distant crossings that require Department of the Army authorization but do not require pre-construction notification (see paragraph (b)(4) of general condition 32). The district engineer will evaluate the PCN in accordance with Section D, "District Engineer's Decision." The district engineer may require mitigation to ensure that the authorized activity results in no more than minimal individual and cumulative adverse environmental effects (see general condition 23).

GENERAL CONDITIONS

Note: To qualify for NWP authorization, the prospective permittee must comply with the following general conditions, as applicable, in addition to any regional or case-specific conditions imposed by the division engineer or district engineer. Prospective permittees should contact the appropriate Corps district office to determine if regional conditions have been imposed on an NWP. Prospective permittees should also contact the appropriate Corps district office to determine the status of Clean Water Act Section 401 water quality certification and/or Coastal Zone Management Act consistency for an NWP. Every person who may wish to obtain permit authorization under one or more NWPs, or who is currently relying on an existing or prior permit authorization under one or more NWPs, has been and is on notice that all of the provisions of 33 CFR 330.1 through 330.6 apply to every NWP authorization. Note especially 33 CFR 330.5 relating to the modification, suspension, or revocation of any NWP authorization.

1. **Navigation.** (a) No activity may cause more than a minimal adverse effect on navigation.

(b) Any safety lights and signals prescribed by the U.S. Coast Guard, through regulations or otherwise, must be installed and maintained at the permittee's expense on authorized facilities in navigable waters of the United States.

(c) The permittee understands and agrees that, if future operations by the United States require the removal, relocation, or other alteration, of the structure or work herein authorized, or if, in the opinion of the Secretary of the Army or his or her authorized representative, said structure or work shall cause unreasonable obstruction to the free navigation of the navigable waters, the permittee will be required, upon due notice from the Corps of Engineers, to remove, relocate, or alter the structural work or obstructions caused thereby, without expense to the United States. No claim shall be made against the United States on account of any such removal or alteration.

2. **Aquatic Life Movements.** No activity may substantially disrupt the necessary life cycle movements of those species of aquatic life indigenous to the waterbody, including those species that normally migrate through the area, unless the activity's primary purpose is to impound water. All permanent and temporary crossings of waterbodies shall be suitably culverted, bridged, or otherwise designed and constructed to maintain low flows to sustain the movement of those aquatic species. If a bottomless culvert cannot be used, then the crossing should be designed and constructed to minimize adverse effects to aquatic life movements.

3. **Spawning Areas.** Activities in spawning areas during spawning seasons must be avoided to the maximum extent practicable. Activities that result in the physical destruction (e.g., through excavation, fill, or downstream smothering by substantial turbidity) of an important spawning area are not authorized.

4. **Migratory Bird Breeding Areas.** Activities in waters of the United States that serve as breeding areas for migratory birds must be avoided to the maximum extent practicable.
5. **Shellfish Beds.** No activity may occur in areas of concentrated shellfish populations, unless the activity is directly related to a shellfish harvesting activity authorized by NWP 4 and 48, or is a shellfish seeding or habitat restoration activity authorized by NWP 27.
6. **Suitable Material.** No activity may use unsuitable material (e.g., trash, debris, car bodies, asphalt, etc.). Material used for construction or discharged must be free from toxic pollutants in toxic amounts (see section 307 of the Clean Water Act).
7. **Water Supply Intakes.** No activity may occur in the proximity of a public water supply intake, except where the activity is for the repair or improvement of public water supply intake structures or adjacent bank stabilization.
8. **Adverse Effects From Impoundments.** If the activity creates an impoundment of water, adverse effects to the aquatic system due to accelerating the passage of water, and/or restricting its flow must be minimized to the maximum extent practicable.
9. **Management of Water Flows.** To the maximum extent practicable, the pre-construction course, condition, capacity, and location of open waters must be maintained for each activity, including stream channelization, storm water management activities, and temporary and permanent road crossings, except as provided below. The activity must be constructed to withstand expected high flows. The activity must not restrict or impede the passage of normal or high flows, unless the primary purpose of the activity is to impound water or manage high flows. The activity may alter the pre-construction course, condition, capacity, and location of open waters if it benefits the aquatic environment (e.g., stream restoration or relocation activities).
10. **Fills Within 100-Year Floodplains.** The activity must comply with applicable FEMA-approved state or local floodplain management requirements.
11. **Equipment.** Heavy equipment working in wetlands or mudflats must be placed on mats, or other measures must be taken to minimize soil disturbance.
12. **Soil Erosion and Sediment Controls.** Appropriate soil erosion and sediment controls must be used and maintained in effective operating condition during construction, and all exposed soil and other fills, as well as any work below the ordinary high water mark or high tide line, must be permanently stabilized at the earliest practicable date. Permittees are encouraged to perform work within waters of the United States during periods of low-flow or no-flow, or during low tides.
13. **Removal of Temporary Structures and Fills.** Temporary structures must be removed, to the maximum extent practicable, after their use has been discontinued.

Temporary fills must be removed in their entirety and the affected areas returned to pre-construction elevations. The affected areas must be revegetated, as appropriate.

14. **Proper Maintenance.** Any authorized structure or fill shall be properly maintained, including maintenance to ensure public safety and compliance with applicable NWP general conditions, as well as any activity-specific conditions added by the district engineer to an NWP authorization.

15. **Single and Complete Project.** The activity must be a single and complete project. The same NWP cannot be used more than once for the same single and complete project.

16. **Wild and Scenic Rivers.** (a) No NWP activity may occur in a component of the National Wild and Scenic River System, or in a river officially designated by Congress as a “study river” for possible inclusion in the system while the river is in an official study status, unless the appropriate Federal agency with direct management responsibility for such river, has determined in writing that the proposed activity will not adversely affect the Wild and Scenic River designation or study status.

(b) If a proposed NWP activity will occur in a component of the National Wild and Scenic River System, or in a river officially designated by Congress as a “study river” for possible inclusion in the system while the river is in an official study status, the permittee must submit a pre-construction notification (see general condition 32). The district engineer will coordinate the PCN with the Federal agency with direct management responsibility for that river. Permittees shall not begin the NWP activity until notified by the district engineer that the Federal agency with direct management responsibility for that river has determined in writing that the proposed NWP activity will not adversely affect the Wild and Scenic River designation or study status.

(c) Information on Wild and Scenic Rivers may be obtained from the appropriate Federal land management agency responsible for the designated Wild and Scenic River or study river (e.g., National Park Service, U.S. Forest Service, Bureau of Land Management, U.S. Fish and Wildlife Service). Information on these rivers is also available at: <http://www.rivers.gov/>.

17. **Tribal Rights.** No activity or its operation may impair reserved tribal rights, including, but not limited to, reserved water rights and treaty fishing and hunting rights.

18. **Endangered Species.** (a) No activity is authorized under any NWP which is likely to directly or indirectly jeopardize the continued existence of a threatened or endangered species or a species proposed for such designation, as identified under the Federal Endangered Species Act (ESA), or which will directly or indirectly destroy or adversely modify designated critical habitat or critical habitat proposed for such designation. No activity is authorized under any NWP which “may affect” a listed species or critical habitat, unless ESA section 7 consultation addressing the consequences of the proposed activity on listed species or critical habitat has been completed. See 50 CFR

402.02 for the definition of “effects of the action” for the purposes of ESA section 7 consultation, as well as 50 CFR 402.17, which provides further explanation under ESA section 7 regarding “activities that are reasonably certain to occur” and “consequences caused by the proposed action.”

(b) Federal agencies should follow their own procedures for complying with the requirements of the ESA (see 33 CFR 330.4(f)(1)). If pre-construction notification is required for the proposed activity, the Federal permittee must provide the district engineer with the appropriate documentation to demonstrate compliance with those requirements. The district engineer will verify that the appropriate documentation has been submitted. If the appropriate documentation has not been submitted, additional ESA section 7 consultation may be necessary for the activity and the respective federal agency would be responsible for fulfilling its obligation under section 7 of the ESA.

(c) Non-federal permittees must submit a pre-construction notification to the district engineer if any listed species (or species proposed for listing) or designated critical habitat (or critical habitat proposed such designation) might be affected or is in the vicinity of the activity, or if the activity is located in designated critical habitat or critical habitat proposed for such designation, and shall not begin work on the activity until notified by the district engineer that the requirements of the ESA have been satisfied and that the activity is authorized. For activities that might affect Federally-listed endangered or threatened species (or species proposed for listing) or designated critical habitat (or critical habitat proposed for such designation), the pre-construction notification must include the name(s) of the endangered or threatened species (or species proposed for listing) that might be affected by the proposed activity or that utilize the designated critical habitat (or critical habitat proposed for such designation) that might be affected by the proposed activity. The district engineer will determine whether the proposed activity “may affect” or will have “no effect” to listed species and designated critical habitat and will notify the non-Federal applicant of the Corps’ determination within 45 days of receipt of a complete pre-construction notification. For activities where the non-Federal applicant has identified listed species (or species proposed for listing) or designated critical habitat (or critical habitat proposed for such designation) that might be affected or is in the vicinity of the activity, and has so notified the Corps, the applicant shall not begin work until the Corps has provided notification that the proposed activity will have “no effect” on listed species (or species proposed for listing or designated critical habitat (or critical habitat proposed for such designation), or until ESA section 7 consultation or conference has been completed. If the non-Federal applicant has not heard back from the Corps within 45 days, the applicant must still wait for notification from the Corps.

(d) As a result of formal or informal consultation or conference with the FWS or NMFS the district engineer may add species-specific permit conditions to the NWP.

(e) Authorization of an activity by an NWP does not authorize the “take” of a threatened or endangered species as defined under the ESA. In the absence of separate authorization (e.g., an ESA Section 10 Permit, a Biological Opinion with “incidental take”

provisions, etc.) from the FWS or the NMFS, the Endangered Species Act prohibits any person subject to the jurisdiction of the United States to take a listed species, where "take" means to harass, harm, pursue, hunt, shoot, wound, kill, trap, capture, or collect, or to attempt to engage in any such conduct. The word "harm" in the definition of "take" means an act which actually kills or injures wildlife. Such an act may include significant habitat modification or degradation where it actually kills or injures wildlife by significantly impairing essential behavioral patterns, including breeding, feeding or sheltering.

(f) If the non-federal permittee has a valid ESA section 10(a)(1)(B) incidental take permit with an approved Habitat Conservation Plan for a project or a group of projects that includes the proposed NWP activity, the non-federal applicant should provide a copy of that ESA section 10(a)(1)(B) permit with the PCN required by paragraph (c) of this general condition. The district engineer will coordinate with the agency that issued the ESA section 10(a)(1)(B) permit to determine whether the proposed NWP activity and the associated incidental take were considered in the internal ESA section 7 consultation conducted for the ESA section 10(a)(1)(B) permit. If that coordination results in concurrence from the agency that the proposed NWP activity and the associated incidental take were considered in the internal ESA section 7 consultation for the ESA section 10(a)(1)(B) permit, the district engineer does not need to conduct a separate ESA section 7 consultation for the proposed NWP activity. The district engineer will notify the non-federal applicant within 45 days of receipt of a complete pre-construction notification whether the ESA section 10(a)(1)(B) permit covers the proposed NWP activity or whether additional ESA section 7 consultation is required.

(g) Information on the location of threatened and endangered species and their critical habitat can be obtained directly from the offices of the FWS and NMFS or their world wide web pages at <http://www.fws.gov/> or <http://www.fws.gov/ipac> and <http://www.nmfs.noaa.gov/pr/species/esa/> respectively.

19. **Migratory Birds and Bald and Golden Eagles.** The permittee is responsible for ensuring that an action authorized by an NWP complies with the Migratory Bird Treaty Act and the Bald and Golden Eagle Protection Act. The permittee is responsible for contacting the appropriate local office of the U.S. Fish and Wildlife Service to determine what measures, if any, are necessary or appropriate to reduce adverse effects to migratory birds or eagles, including whether "incidental take" permits are necessary and available under the Migratory Bird Treaty Act or Bald and Golden Eagle Protection Act for a particular activity.

20. **Historic Properties.** (a) No activity is authorized under any NWP which may have the potential to cause effects to properties listed, or eligible for listing, in the National Register of Historic Places until the requirements of Section 106 of the National Historic Preservation Act (NHPA) have been satisfied.

(b) Federal permittees should follow their own procedures for complying with the requirements of section 106 of the National Historic Preservation Act (see 33 CFR

330.4(g)(1)). If pre-construction notification is required for the proposed NWP activity, the Federal permittee must provide the district engineer with the appropriate documentation to demonstrate compliance with those requirements. The district engineer will verify that the appropriate documentation has been submitted. If the appropriate documentation is not submitted, then additional consultation under section 106 may be necessary. The respective federal agency is responsible for fulfilling its obligation to comply with section 106.

(c) Non-federal permittees must submit a pre-construction notification to the district engineer if the NWP activity might have the potential to cause effects to any historic properties listed on, determined to be eligible for listing on, or potentially eligible for listing on the National Register of Historic Places, including previously unidentified properties. For such activities, the pre-construction notification must state which historic properties might have the potential to be affected by the proposed NWP activity or include a vicinity map indicating the location of the historic properties or the potential for the presence of historic properties. Assistance regarding information on the location of, or potential for, the presence of historic properties can be sought from the State Historic Preservation Officer, Tribal Historic Preservation Officer, or designated tribal representative, as appropriate, and the National Register of Historic Places (see 33 CFR 330.4(g)). When reviewing pre-construction notifications, district engineers will comply with the current procedures for addressing the requirements of section 106 of the National Historic Preservation Act. The district engineer shall make a reasonable and good faith effort to carry out appropriate identification efforts commensurate with potential impacts, which may include background research, consultation, oral history interviews, sample field investigation, and/or field survey. Based on the information submitted in the PCN and these identification efforts, the district engineer shall determine whether the proposed NWP activity has the potential to cause effects on the historic properties. Section 106 consultation is not required when the district engineer determines that the activity does not have the potential to cause effects on historic properties (see 36 CFR 800.3(a)). Section 106 consultation is required when the district engineer determines that the activity has the potential to cause effects on historic properties. The district engineer will conduct consultation with consulting parties identified under 36 CFR 800.2(c) when he or she makes any of the following effect determinations for the purposes of section 106 of the NHPA: no historic properties affected, no adverse effect, or adverse effect.

(d) Where the non-Federal applicant has identified historic properties on which the proposed NWP activity might have the potential to cause effects and has so notified the Corps, the non-Federal applicant shall not begin the activity until notified by the district engineer either that the activity has no potential to cause effects to historic properties or that NHPA section 106 consultation has been completed. For non-federal permittees, the district engineer will notify the prospective permittee within 45 days of receipt of a complete pre-construction notification whether NHPA section 106 consultation is required. If NHPA section 106 consultation is required, the district engineer will notify the non-Federal applicant that he or she cannot begin the activity until section 106

consultation is completed. If the non-Federal applicant has not heard back from the Corps within 45 days, the applicant must still wait for notification from the Corps.

(e) Prospective permittees should be aware that section 110k of the NHPA (54 U.S.C. 306113) prevents the Corps from granting a permit or other assistance to an applicant who, with intent to avoid the requirements of section 106 of the NHPA, has intentionally significantly adversely affected a historic property to which the permit would relate, or having legal power to prevent it, allowed such significant adverse effect to occur, unless the Corps, after consultation with the Advisory Council on Historic Preservation (ACHP), determines that circumstances justify granting such assistance despite the adverse effect created or permitted by the applicant. If circumstances justify granting the assistance, the Corps is required to notify the ACHP and provide documentation specifying the circumstances, the degree of damage to the integrity of any historic properties affected, and proposed mitigation. This documentation must include any views obtained from the applicant, SHPO/THPO, appropriate Indian tribes if the undertaking occurs on or affects historic properties on tribal lands or affects properties of interest to those tribes, and other parties known to have a legitimate interest in the impacts to the permitted activity on historic properties.

21. **Discovery of Previously Unknown Remains and Artifacts.** Permittees that discover any previously unknown historic, cultural or archeological remains and artifacts while accomplishing the activity authorized by an NWP, they must immediately notify the district engineer of what they have found, and to the maximum extent practicable, avoid construction activities that may affect the remains and artifacts until the required coordination has been completed. The district engineer will initiate the Federal, Tribal, and state coordination required to determine if the items or remains warrant a recovery effort or if the site is eligible for listing in the National Register of Historic Places.

22. **Designated Critical Resource Waters.** Critical resource waters include, NOAA-managed marine sanctuaries and marine monuments, and National Estuarine Research Reserves. The district engineer may designate, after notice and opportunity for public comment, additional waters officially designated by a state as having particular environmental or ecological significance, such as outstanding national resource waters or state natural heritage sites. The district engineer may also designate additional critical resource waters after notice and opportunity for public comment.

(a) Discharges of dredged or fill material into waters of the United States are not authorized by NWPs 7, 12, 14, 16, 17, 21, 29, 31, 35, 39, 40, 42, 43, 44, 49, 50, 51, 52, 57 and 58 for any activity within, or directly affecting, critical resource waters, including wetlands adjacent to such waters.

(b) For NWPs 3, 8, 10, 13, 15, 18, 19, 22, 23, 25, 27, 28, 30, 33, 34, 36, 37, 38, and 54, notification is required in accordance with general condition 32, for any activity proposed by permittees in the designated critical resource waters including wetlands adjacent to those waters. The district engineer may authorize activities under these NWPs only

after she or he determines that the impacts to the critical resource waters will be no more than minimal.

23. **Mitigation.** The district engineer will consider the following factors when determining appropriate and practicable mitigation necessary to ensure that the individual and cumulative adverse environmental effects are no more than minimal:

(a) The activity must be designed and constructed to avoid and minimize adverse effects, both temporary and permanent, to waters of the United States to the maximum extent practicable at the project site (i.e., on site).

(b) Mitigation in all its forms (avoiding, minimizing, rectifying, reducing, or compensating for resource losses) will be required to the extent necessary to ensure that the individual and cumulative adverse environmental effects are no more than minimal.

(c) Compensatory mitigation at a minimum one-for-one ratio will be required for all wetland losses that exceed 1/10-acre and require pre-construction notification, unless the district engineer determines in writing that either some other form of mitigation would be more environmentally appropriate or the adverse environmental effects of the proposed activity are no more than minimal, and provides an activity-specific waiver of this requirement. For wetland losses of 1/10-acre or less that require pre-construction notification, the district engineer may determine on a case-by-case basis that compensatory mitigation is required to ensure that the activity results in only minimal adverse environmental effects.

(d) Compensatory mitigation at a minimum one-for-one ratio will be required for all losses of stream bed that exceed 3/100-acre and require pre-construction notification, unless the district engineer determines in writing that either some other form of mitigation would be more environmentally appropriate or the adverse environmental effects of the proposed activity are no more than minimal, and provides an activity-specific waiver of this requirement. This compensatory mitigation requirement may be satisfied through the restoration or enhancement of riparian areas next to streams in accordance with paragraph (e) of this general condition. For losses of stream bed of 3/100-acre or less that require pre-construction notification, the district engineer may determine on a case-by-case basis that compensatory mitigation is required to ensure that the activity results in only minimal adverse environmental effects. Compensatory mitigation for losses of streams should be provided, if practicable, through stream rehabilitation, enhancement, or preservation, since streams are difficult-to-replace resources (see 33 CFR 332.3(e)(3)).

(e) Compensatory mitigation plans for NWP activities in or near streams or other open waters will normally include a requirement for the restoration or enhancement, maintenance, and legal protection (e.g., conservation easements) of riparian areas next to open waters. In some cases, the restoration or maintenance/protection of riparian areas may be the only compensatory mitigation required. If restoring riparian areas involves planting vegetation, only native species should be planted. The width of the

required riparian area will address documented water quality or aquatic habitat loss concerns. Normally, the riparian area will be 25 to 50 feet wide on each side of the stream, but the district engineer may require slightly wider riparian areas to address documented water quality or habitat loss concerns. If it is not possible to restore or maintain/protect a riparian area on both sides of a stream, or if the waterbody is a lake or coastal waters, then restoring or maintaining/protecting a riparian area along a single bank or shoreline may be sufficient. Where both wetlands and open waters exist on the project site, the district engineer will determine the appropriate compensatory mitigation (e.g., riparian areas and/or wetlands compensation) based on what is best for the aquatic environment on a watershed basis. In cases where riparian areas are determined to be the most appropriate form of minimization or compensatory mitigation, the district engineer may waive or reduce the requirement to provide wetland compensatory mitigation for wetland losses.

(f) Compensatory mitigation projects provided to offset losses of aquatic resources must comply with the applicable provisions of 33 CFR part 332.

(1) The prospective permittee is responsible for proposing an appropriate compensatory mitigation option if compensatory mitigation is necessary to ensure that the activity results in no more than minimal adverse environmental effects. For the NWP, the preferred mechanism for providing compensatory mitigation is mitigation bank credits or in-lieu fee program credits (see 33 CFR 332.3(b)(2) and (3)). However, if an appropriate number and type of mitigation bank or in-lieu credits are not available at the time the PCN is submitted to the district engineer, the district engineer may approve the use of permittee-responsible mitigation.

(2) The amount of compensatory mitigation required by the district engineer must be sufficient to ensure that the authorized activity results in no more than minimal individual and cumulative adverse environmental effects (see 33 CFR 330.1(e)(3)). (See also 33 CFR 332.3(f).)

(3) Since the likelihood of success is greater and the impacts to potentially valuable uplands are reduced, aquatic resource restoration should be the first compensatory mitigation option considered for permittee-responsible mitigation.

(4) If permittee-responsible mitigation is the proposed option, the prospective permittee is responsible for submitting a mitigation plan. A conceptual or detailed mitigation plan may be used by the district engineer to make the decision on the NWP verification request, but a final mitigation plan that addresses the applicable requirements of 33 CFR 332.4(c)(2) through (14) must be approved by the district engineer before the permittee begins work in waters of the United States, unless the district engineer determines that prior approval of the final mitigation plan is not practicable or not necessary to ensure timely completion of the required compensatory mitigation (see 33 CFR 332.3(k)(3)). If permittee-responsible mitigation is the proposed option, and the proposed compensatory mitigation site is located on land in which another federal agency holds an easement, the district engineer will coordinate with that federal agency

to determine if proposed compensatory mitigation project is compatible with the terms of the easement.

(5) If mitigation bank or in-lieu fee program credits are the proposed option, the mitigation plan needs to address only the baseline conditions at the impact site and the number of credits to be provided (see 33 CFR 332.4(c)(1)(ii)).

(6) Compensatory mitigation requirements (e.g., resource type and amount to be provided as compensatory mitigation, site protection, ecological performance standards, monitoring requirements) may be addressed through conditions added to the NWP authorization, instead of components of a compensatory mitigation plan (see 33 CFR 332.4(c)(1)(ii)).

(g) Compensatory mitigation will not be used to increase the acreage losses allowed by the acreage limits of the NWPs. For example, if an NWP has an acreage limit of 1/2-acre, it cannot be used to authorize any NWP activity resulting in the loss of greater than 1/2-acre of waters of the United States, even if compensatory mitigation is provided that replaces or restores some of the lost waters. However, compensatory mitigation can and should be used, as necessary, to ensure that an NWP activity already meeting the established acreage limits also satisfies the no more than minimal impact requirement for the NWPs.

(h) Permittees may propose the use of mitigation banks, in-lieu fee programs, or permittee-responsible mitigation. When developing a compensatory mitigation proposal, the permittee must consider appropriate and practicable options consistent with the framework at 33 CFR 332.3(b). For activities resulting in the loss of marine or estuarine resources, permittee-responsible mitigation may be environmentally preferable if there are no mitigation banks or in-lieu fee programs in the area that have marine or estuarine credits available for sale or transfer to the permittee. For permittee-responsible mitigation, the special conditions of the NWP verification must clearly indicate the party or parties responsible for the implementation and performance of the compensatory mitigation project, and, if required, its long-term management.

(i) Where certain functions and services of waters of the United States are permanently adversely affected by a regulated activity, such as discharges of dredged or fill material into waters of the United States that will convert a forested or scrub-shrub wetland to a herbaceous wetland in a permanently maintained utility line right-of-way, mitigation may be required to reduce the adverse environmental effects of the activity to the no more than minimal level.

24. Safety of Impoundment Structures. To ensure that all impoundment structures are safely designed, the district engineer may require non-Federal applicants to demonstrate that the structures comply with established state or federal, dam safety criteria or have been designed by qualified persons. The district engineer may also require documentation that the design has been independently reviewed by similarly qualified persons, and appropriate modifications made to ensure safety.

25. **Water Quality.** (a) Where the certifying authority (state, authorized tribe, or EPA, as appropriate) has not previously certified compliance of an NWP with CWA section 401, a CWA section 401 water quality certification for the proposed discharge must be obtained or waived (see 33 CFR 330.4(c)). If the permittee cannot comply with all of the conditions of a water quality certification previously issued by certifying authority for the issuance of the NWP, then the permittee must obtain a water quality certification or waiver for the proposed discharge in order for the activity to be authorized by an NWP.

(b) If the NWP activity requires pre-construction notification and the certifying authority has not previously certified compliance of an NWP with CWA section 401, the proposed discharge is not authorized by an NWP until water quality certification is obtained or waived. If the certifying authority issues a water quality certification for the proposed discharge, the permittee must submit a copy of the certification to the district engineer. The discharge is not authorized by an NWP until the district engineer has notified the permittee that the water quality certification requirement has been satisfied by the issuance of a water quality certification or a waiver.

(c) The district engineer or certifying authority may require additional water quality management measures to ensure that the authorized activity does not result in more than minimal degradation of water quality.

26. **Coastal Zone Management.** In coastal states where an NWP has not previously received a state coastal zone management consistency concurrence, an individual state coastal zone management consistency concurrence must be obtained, or a presumption of concurrence must occur (see 33 CFR 330.4(d)). If the permittee cannot comply with all of the conditions of a coastal zone management consistency concurrence previously issued by the state, then the permittee must obtain an individual coastal zone management consistency concurrence or presumption of concurrence in order for the activity to be authorized by an NWP. The district engineer or a state may require additional measures to ensure that the authorized activity is consistent with state coastal zone management requirements.

27. **Regional and Case-By-Case Conditions.** The activity must comply with any regional conditions that may have been added by the Division Engineer (see 33 CFR 330.4(e)) and with any case specific conditions added by the Corps or by the state, Indian Tribe, or U.S. EPA in its CWA section 401 Water Quality Certification, or by the state in its Coastal Zone Management Act consistency determination.

28. **Use of Multiple Nationwide Permits.** The use of more than one NWP for a single and complete project is authorized, subject to the following restrictions:

(a) If only one of the NWPs used to authorize the single and complete project has a specified acreage limit, the acreage loss of waters of the United States cannot exceed the acreage limit of the NWP with the highest specified acreage limit. For example, if a road crossing over tidal waters is constructed under NWP 14, with associated bank

stabilization authorized by NWP 13, the maximum acreage loss of waters of the United States for the total project cannot exceed 1/3-acre.

(b) If one or more of the NWPs used to authorize the single and complete project has specified acreage limits, the acreage loss of waters of the United States authorized by those NWPs cannot exceed their respective specified acreage limits. For example, if a commercial development is constructed under NWP 39, and the single and complete project includes the filling of an upland ditch authorized by NWP 46, the maximum acreage loss of waters of the United States for the commercial development under NWP 39 cannot exceed 1/2-acre, and the total acreage loss of waters of United States due to the NWP 39 and 46 activities cannot exceed 1 acre.

29. **Transfer of Nationwide Permit Verifications.** If the permittee sells the property associated with a nationwide permit verification, the permittee may transfer the nationwide permit verification to the new owner by submitting a letter to the appropriate Corps district office to validate the transfer. A copy of the nationwide permit verification must be attached to the letter, and the letter must contain the following statement and signature:

“When the structures or work authorized by this nationwide permit are still in existence at the time the property is transferred, the terms and conditions of this nationwide permit, including any special conditions, will continue to be binding on the new owner(s) of the property. To validate the transfer of this nationwide permit and the associated liabilities associated with compliance with its terms and conditions, have the transferee sign and date below.”

(Transferee)

(Date)

30. **Compliance Certification.** Each permittee who receives an NWP verification letter from the Corps must provide a signed certification documenting completion of the authorized activity and implementation of any required compensatory mitigation. The success of any required permittee-responsible mitigation, including the achievement of ecological performance standards, will be addressed separately by the district engineer. The Corps will provide the permittee the certification document with the NWP verification letter. The certification document will include:

(a) A statement that the authorized activity was done in accordance with the NWP authorization, including any general, regional, or activity-specific conditions;

(b) A statement that the implementation of any required compensatory mitigation was completed in accordance with the permit conditions. If credits from a mitigation bank or in-lieu fee program are used to satisfy the compensatory mitigation requirements, the certification must include the documentation required by 33 CFR 332.3(l)(3) to confirm that the permittee secured the appropriate number and resource type of credits; and

(c) The signature of the permittee certifying the completion of the activity and mitigation.

The completed certification document must be submitted to the district engineer within 30 days of completion of the authorized activity or the implementation of any required compensatory mitigation, whichever occurs later.

31. **Activities Affecting Structures or Works Built by the United States.** If an NWP activity also requires review by, or permission from, the Corps pursuant to 33 U.S.C. 408 because it will alter or temporarily or permanently occupy or use a U.S. Army Corps of Engineers (USACE) federally authorized Civil Works project (a "USACE project"), the prospective permittee must submit a pre-construction notification. See paragraph (b)(10) of general condition 32. An activity that requires section 408 permission and/or review is not authorized by an NWP until the appropriate Corps office issues the section 408 permission or completes its review to alter, occupy, or use the USACE project, and the district engineer issues a written NWP verification.

32. **Pre-Construction Notification.** (a) *Timing.* Where required by the terms of the NWP, the prospective permittee must notify the district engineer by submitting a pre-construction notification (PCN) as early as possible. The district engineer must determine if the PCN is complete within 30 calendar days of the date of receipt and, if the PCN is determined to be incomplete, notify the prospective permittee within that 30 day period to request the additional information necessary to make the PCN complete. The request must specify the information needed to make the PCN complete. As a general rule, district engineers will request additional information necessary to make the PCN complete only once. However, if the prospective permittee does not provide all of the requested information, then the district engineer will notify the prospective permittee that the PCN is still incomplete and the PCN review process will not commence until all of the requested information has been received by the district engineer. The prospective permittee shall not begin the activity until either:

(1) He or she is notified in writing by the district engineer that the activity may proceed under the NWP with any special conditions imposed by the district or division engineer; or

(2) 45 calendar days have passed from the district engineer's receipt of the complete PCN and the prospective permittee has not received written notice from the district or division engineer. However, if the permittee was required to notify the Corps pursuant to general condition 18 that listed species or critical habitat might be affected or are in the vicinity of the activity, or to notify the Corps pursuant to general condition 20 that the activity might have the potential to cause effects to historic properties, the permittee

cannot begin the activity until receiving written notification from the Corps that there is “no effect” on listed species or “no potential to cause effects” on historic properties, or that any consultation required under Section 7 of the Endangered Species Act (see 33 CFR 330.4(f)) and/or section 106 of the National Historic Preservation Act (see 33 CFR 330.4(g)) has been completed. If the proposed activity requires a written waiver to exceed specified limits of an NWP, the permittee may not begin the activity until the district engineer issues the waiver. If the district or division engineer notifies the permittee in writing that an individual permit is required within 45 calendar days of receipt of a complete PCN, the permittee cannot begin the activity until an individual permit has been obtained. Subsequently, the permittee’s right to proceed under the NWP may be modified, suspended, or revoked only in accordance with the procedure set forth in 33 CFR 330.5(d)(2).

(b) *Contents of Pre-Construction Notification:* The PCN must be in writing and include the following information:

(1) Name, address and telephone numbers of the prospective permittee;

(2) Location of the proposed activity;

(3) Identify the specific NWP or NWP(s) the prospective permittee wants to use to authorize the proposed activity;

(4) (i) A description of the proposed activity; the activity’s purpose; direct and indirect adverse environmental effects the activity would cause, including the anticipated amount of loss of wetlands, other special aquatic sites, and other waters expected to result from the NWP activity, in acres, linear feet, or other appropriate unit of measure; a description of any proposed mitigation measures intended to reduce the adverse environmental effects caused by the proposed activity; and any other NWP(s), regional general permit(s), or individual permit(s) used or intended to be used to authorize any part of the proposed project or any related activity, including other separate and distant crossings for linear projects that require Department of the Army authorization but do not require pre-construction notification. The description of the proposed activity and any proposed mitigation measures should be sufficiently detailed to allow the district engineer to determine that the adverse environmental effects of the activity will be no more than minimal and to determine the need for compensatory mitigation or other mitigation measures.

(ii) For linear projects where one or more single and complete crossings require pre-construction notification, the PCN must include the quantity of anticipated losses of wetlands, other special aquatic sites, and other waters for each single and complete crossing of those wetlands, other special aquatic sites, and other waters (including those single and complete crossings authorized by an NWP but do not require PCNs). This information will be used by the district engineer to evaluate the cumulative adverse environmental effects of the proposed linear project, and does not change those non-PCN NWP activities into NWP PCNs.

(iii) Sketches should be provided when necessary to show that the activity complies with the terms of the NWP. (Sketches usually clarify the activity and when provided results in a quicker decision. Sketches should contain sufficient detail to provide an illustrative description of the proposed activity (e.g., a conceptual plan), but do not need to be detailed engineering plans);

(5) The PCN must include a delineation of wetlands, other special aquatic sites, and other waters, such as lakes and ponds, and perennial and intermittent streams, on the project site. Wetland delineations must be prepared in accordance with the current method required by the Corps. The permittee may ask the Corps to delineate the special aquatic sites and other waters on the project site, but there may be a delay if the Corps does the delineation, especially if the project site is large or contains many wetlands, other special aquatic sites, and other waters. Furthermore, the 45-day period will not start until the delineation has been submitted to or completed by the Corps, as appropriate;

(6) If the proposed activity will result in the loss of greater than 1/10-acre of wetlands or 3/100-acre of stream bed and a PCN is required, the prospective permittee must submit a statement describing how the mitigation requirement will be satisfied, or explaining why the adverse environmental effects are no more than minimal and why compensatory mitigation should not be required. As an alternative, the prospective permittee may submit a conceptual or detailed mitigation plan.

(7) For non-federal permittees, if any listed species (or species proposed for listing) or designated critical habitat (or critical habitat proposed for such designation) might be affected or is in the vicinity of the activity, or if the activity is located in designated critical habitat (or critical habitat proposed for such designation), the PCN must include the name(s) of those endangered or threatened species (or species proposed for listing) that might be affected by the proposed activity or utilize the designated critical habitat (or critical habitat proposed for such designation) that might be affected by the proposed activity. For NWP activities that require pre-construction notification, Federal permittees must provide documentation demonstrating compliance with the Endangered Species Act;

(8) For non-federal permittees, if the NWP activity might have the potential to cause effects to a historic property listed on, determined to be eligible for listing on, or potentially eligible for listing on, the National Register of Historic Places, the PCN must state which historic property might have the potential to be affected by the proposed activity or include a vicinity map indicating the location of the historic property. For NWP activities that require pre-construction notification, Federal permittees must provide documentation demonstrating compliance with section 106 of the National Historic Preservation Act;

(9) For an activity that will occur in a component of the National Wild and Scenic River System, or in a river officially designated by Congress as a "study river" for possible

inclusion in the system while the river is in an official study status, the PCN must identify the Wild and Scenic River or the “study river” (see general condition 16); and

(10) For an NWP activity that requires permission from, or review by, the Corps pursuant to 33 U.S.C. 408 because it will alter or temporarily or permanently occupy or use a U.S. Army Corps of Engineers federally authorized civil works project, the pre-construction notification must include a statement confirming that the project proponent has submitted a written request for section 408 permission from, or review by, the Corps office having jurisdiction over that USACE project.

(c) *Form of Pre-Construction Notification:* The nationwide permit pre-construction notification form (Form ENG 6082) should be used for NWP PCNs. A letter containing the required information may also be used. Applicants may provide electronic files of PCNs and supporting materials if the district engineer has established tools and procedures for electronic submittals.

(d) *Agency Coordination:* (1) The district engineer will consider any comments from Federal and state agencies concerning the proposed activity’s compliance with the terms and conditions of the NWPs and the need for mitigation to reduce the activity’s adverse environmental effects so that they are no more than minimal.

(2) Agency coordination is required for: (i) all NWP activities that require pre-construction notification and result in the loss of greater than 1/2-acre of waters of the United States; (ii) NWP 13 activities in excess of 500 linear feet, fills greater than one cubic yard per running foot, or involve discharges of dredged or fill material into special aquatic sites; and (iii) NWP 54 activities in excess of 500 linear feet, or that extend into the waterbody more than 30 feet from the mean low water line in tidal waters or the ordinary high water mark in the Great Lakes.

(3) When agency coordination is required, the district engineer will immediately provide (e.g., via e-mail, facsimile transmission, overnight mail, or other expeditious manner) a copy of the complete PCN to the appropriate Federal or state offices (FWS, state natural resource or water quality agency, EPA, and, if appropriate, the NMFS). With the exception of NWP 37, these agencies will have 10 calendar days from the date the material is transmitted to notify the district engineer via telephone, facsimile transmission, or e-mail that they intend to provide substantive, site-specific comments. The comments must explain why the agency believes the adverse environmental effects will be more than minimal. If so contacted by an agency, the district engineer will wait an additional 15 calendar days before making a decision on the pre-construction notification. The district engineer will fully consider agency comments received within the specified time frame concerning the proposed activity’s compliance with the terms and conditions of the NWPs, including the need for mitigation to ensure that the net adverse environmental effects of the proposed activity are no more than minimal. The district engineer will provide no response to the resource agency, except as provided below. The district engineer will indicate in the administrative record associated with each pre-construction notification that the resource agencies’ concerns were

considered. For NWP 37, the emergency watershed protection and rehabilitation activity may proceed immediately in cases where there is an unacceptable hazard to life or a significant loss of property or economic hardship will occur. The district engineer will consider any comments received to decide whether the NWP 37 authorization should be modified, suspended, or revoked in accordance with the procedures at 33 CFR 330.5.

(4) In cases of where the prospective permittee is not a Federal agency, the district engineer will provide a response to NMFS within 30 calendar days of receipt of any Essential Fish Habitat conservation recommendations, as required by section 305(b)(4)(B) of the Magnuson-Stevens Fishery Conservation and Management Act.

(5) Applicants are encouraged to provide the Corps with either electronic files or multiple copies of pre-construction notifications to expedite agency coordination.

District Engineer's Decision

1. In reviewing the PCN for the proposed activity, the district engineer will determine whether the activity authorized by the NWP will result in more than minimal individual or cumulative adverse environmental effects or may be contrary to the public interest. If a project proponent requests authorization by a specific NWP, the district engineer should issue the NWP verification for that activity if it meets the terms and conditions of that NWP, unless he or she determines, after considering mitigation, that the proposed activity will result in more than minimal individual and cumulative adverse effects on the aquatic environment and other aspects of the public interest and exercises discretionary authority to require an individual permit for the proposed activity. For a linear project, this determination will include an evaluation of the single and complete crossings of waters of the United States that require PCNs to determine whether they individually satisfy the terms and conditions of the NWP(s), as well as the cumulative effects caused by all of the crossings of waters of the United States authorized by an NWP. If an applicant requests a waiver of an applicable limit, as provided for in NWPs 13, 36, or 54, the district engineer will only grant the waiver upon a written determination that the NWP activity will result in only minimal individual and cumulative adverse environmental effects.

2. When making minimal adverse environmental effects determinations the district engineer will consider the direct and indirect effects caused by the NWP activity. He or she will also consider the cumulative adverse environmental effects caused by activities authorized by an NWP and whether those cumulative adverse environmental effects are no more than minimal. The district engineer will also consider site specific factors, such as the environmental setting in the vicinity of the NWP activity, the type of resource that will be affected by the NWP activity, the functions provided by the aquatic resources that will be affected by the NWP activity, the degree or magnitude to which the aquatic resources perform those functions, the extent that aquatic resource functions will be lost as a result of the NWP activity (e.g., partial or complete loss), the duration of the adverse effects (temporary or permanent), the importance of the aquatic resource

functions to the region (e.g., watershed or ecoregion), and mitigation required by the district engineer. If an appropriate functional or condition assessment method is available and practicable to use, that assessment method may be used by the district engineer to assist in the minimal adverse environmental effects determination. The district engineer may add case-specific special conditions to the NWP authorization to address site-specific environmental concerns.

3. If the proposed activity requires a PCN and will result in a loss of greater than 1/10-acre of wetlands or 3/100-acre of stream bed, the prospective permittee should submit a mitigation proposal with the PCN. Applicants may also propose compensatory mitigation for NWP activities with smaller impacts, or for impacts to other types of waters. The district engineer will consider any proposed compensatory mitigation or other mitigation measures the applicant has included in the proposal in determining whether the net adverse environmental effects of the proposed activity are no more than minimal. The compensatory mitigation proposal may be either conceptual or detailed. If the district engineer determines that the activity complies with the terms and conditions of the NWP and that the adverse environmental effects are no more than minimal, after considering mitigation, the district engineer will notify the permittee and include any activity-specific conditions in the NWP verification the district engineer deems necessary. Conditions for compensatory mitigation requirements must comply with the appropriate provisions at 33 CFR 332.3(k). The district engineer must approve the final mitigation plan before the permittee commences work in waters of the United States, unless the district engineer determines that prior approval of the final mitigation plan is not practicable or not necessary to ensure timely completion of the required compensatory mitigation. If the prospective permittee elects to submit a compensatory mitigation plan with the PCN, the district engineer will expeditiously review the proposed compensatory mitigation plan. The district engineer must review the proposed compensatory mitigation plan within 45 calendar days of receiving a complete PCN and determine whether the proposed mitigation would ensure that the NWP activity results in no more than minimal adverse environmental effects. If the net adverse environmental effects of the NWP activity (after consideration of the mitigation proposal) are determined by the district engineer to be no more than minimal, the district engineer will provide a timely written response to the applicant. The response will state that the NWP activity can proceed under the terms and conditions of the NWP, including any activity-specific conditions added to the NWP authorization by the district engineer.

4. If the district engineer determines that the adverse environmental effects of the proposed activity are more than minimal, then the district engineer will notify the applicant either: (a) that the activity does not qualify for authorization under the NWP and instruct the applicant on the procedures to seek authorization under an individual permit; (b) that the activity is authorized under the NWP subject to the applicant's submission of a mitigation plan that would reduce the adverse environmental effects so that they are no more than minimal; or (c) that the activity is authorized under the NWP with specific modifications or conditions. Where the district engineer determines that mitigation is required to ensure no more than minimal adverse environmental effects, the activity will be authorized within the 45-day PCN period (unless additional time is

required to comply with general conditions 18, 20, and/or 31), with activity-specific conditions that state the mitigation requirements. The authorization will include the necessary conceptual or detailed mitigation plan or a requirement that the applicant submit a mitigation plan that would reduce the adverse environmental effects so that they are no more than minimal. When compensatory mitigation is required, no work in waters of the United States may occur until the district engineer has approved a specific mitigation plan or has determined that prior approval of a final mitigation plan is not practicable or not necessary to ensure timely completion of the required compensatory mitigation.

Further Information

1. District engineers have authority to determine if an activity complies with the terms and conditions of an NWP.
2. NWPs do not obviate the need to obtain other federal, state, or local permits, approvals, or authorizations required by law.
3. NWPs do not grant any property rights or exclusive privileges.
4. NWPs do not authorize any injury to the property or rights of others.
5. NWPs do not authorize interference with any existing or proposed Federal project (see general condition 31).

Definitions

Best management practices (BMPs): Policies, practices, procedures, or structures implemented to mitigate the adverse environmental effects on surface water quality resulting from development. BMPs are categorized as structural or non-structural.

Compensatory mitigation: The restoration (re-establishment or rehabilitation), establishment (creation), enhancement, and/or in certain circumstances preservation of aquatic resources for the purposes of offsetting unavoidable adverse impacts which remain after all appropriate and practicable avoidance and minimization has been achieved.

Currently serviceable: Useable as is or with some maintenance, but not so degraded as to essentially require reconstruction.

Direct effects: Effects that are caused by the activity and occur at the same time and place.

Discharge: The term “discharge” means any discharge of dredged or fill material into waters of the United States.

Ecological reference: A model used to plan and design an aquatic habitat and riparian area restoration, enhancement, or establishment activity under NWP 27. An ecological reference may be based on the structure, functions, and dynamics of an aquatic habitat type or a riparian area type that currently exists in the region where the proposed NWP 27 activity is located. Alternatively, an ecological reference may be based on a conceptual model for the aquatic habitat type or riparian area type to be restored, enhanced, or established as a result of the proposed NWP 27 activity. An ecological reference takes into account the range of variation of the aquatic habitat type or riparian area type in the region.

Enhancement: The manipulation of the physical, chemical, or biological characteristics of an aquatic resource to heighten, intensify, or improve a specific aquatic resource function(s). Enhancement results in the gain of selected aquatic resource function(s), but may also lead to a decline in other aquatic resource function(s). Enhancement does not result in a gain in aquatic resource area.

Establishment (creation): The manipulation of the physical, chemical, or biological characteristics present to develop an aquatic resource that did not previously exist at an upland site. Establishment results in a gain in aquatic resource area.

High Tide Line: The line of intersection of the land with the water's surface at the maximum height reached by a rising tide. The high tide line may be determined, in the absence of actual data, by a line of oil or scum along shore objects, a more or less continuous deposit of fine shell or debris on the foreshore or berm, other physical markings or characteristics, vegetation lines, tidal gages, or other suitable means that delineate the general height reached by a rising tide. The line encompasses spring high tides and other high tides that occur with periodic frequency but does not include storm surges in which there is a departure from the normal or predicted reach of the tide due to the piling up of water against a coast by strong winds such as those accompanying a hurricane or other intense storm.

Historic Property: Any prehistoric or historic district, site (including archaeological site), building, structure, or other object included in, or eligible for inclusion in, the National Register of Historic Places maintained by the Secretary of the Interior. This term includes artifacts, records, and remains that are related to and located within such properties. The term includes properties of traditional religious and cultural importance to an Indian tribe or Native Hawaiian organization and that meet the National Register criteria (36 CFR part 60).

Independent utility: A test to determine what constitutes a single and complete non-linear project in the Corps Regulatory Program. A project is considered to have independent utility if it would be constructed absent the construction of other projects in the project area. Portions of a multi-phase project that depend upon other phases of the project do not have independent utility. Phases of a project that would be constructed even if the other phases were not built can be considered as separate single and complete projects with independent utility.

Indirect effects: Effects that are caused by the activity and are later in time or farther removed in distance, but are still reasonably foreseeable.

Loss of waters of the United States: Waters of the United States that are permanently adversely affected by filling, flooding, excavation, or drainage because of the regulated activity. The loss of stream bed includes the acres of stream bed that are permanently adversely affected by filling or excavation because of the regulated activity. Permanent adverse effects include permanent discharges of dredged or fill material that change an aquatic area to dry land, increase the bottom elevation of a waterbody, or change the use of a waterbody. The acreage of loss of waters of the United States is a threshold measurement of the impact to jurisdictional waters or wetlands for determining whether a project may qualify for an NWP; it is not a net threshold that is calculated after considering compensatory mitigation that may be used to offset losses of aquatic functions and services. Waters of the United States temporarily filled, flooded, excavated, or drained, but restored to pre-construction contours and elevations after construction, are not included in the measurement of loss of waters of the United States. Impacts resulting from activities that do not require Department of the Army authorization, such as activities eligible for exemptions under section 404(f) of the Clean Water Act, are not considered when calculating the loss of waters of the United States.

Navigable waters: Waters subject to section 10 of the Rivers and Harbors Act of 1899. These waters are defined at 33 CFR part 329.

Non-tidal wetland: A non-tidal wetland is a wetland that is not subject to the ebb and flow of tidal waters. Non-tidal wetlands contiguous to tidal waters are located landward of the high tide line (i.e., spring high tide line).

Open water: For purposes of the NWPs, an open water is any area that in a year with normal patterns of precipitation has water flowing or standing above ground to the extent that an ordinary high water mark can be determined. Aquatic vegetation within the area of flowing or standing water is either non-emergent, sparse, or absent. Vegetated shallows are considered to be open waters. Examples of “open waters” include rivers, streams, lakes, and ponds.

Ordinary High Water Mark: The term ordinary high water mark means that line on the shore established by the fluctuations of water and indicated by physical characteristics such as a clear, natural line impressed on the bank, shelving, changes in the character of soil, destruction of terrestrial vegetation, the presence of litter and debris, or other appropriate means that consider the characteristics of the surrounding areas.

Perennial stream: A perennial stream has surface water flowing continuously year-round during a typical year.

Practicable: Available and capable of being done after taking into consideration cost, existing technology, and logistics in light of overall project purposes.

Pre-construction notification: A request submitted by the project proponent to the Corps for confirmation that a particular activity is authorized by nationwide permit. The request may be a permit application, letter, or similar document that includes information about the proposed work and its anticipated environmental effects. Pre-construction notification may be required by the terms and conditions of a nationwide permit, or by regional conditions. A pre-construction notification may be voluntarily submitted in cases where pre-construction notification is not required and the project proponent wants confirmation that the activity is authorized by nationwide permit.

Preservation: The removal of a threat to, or preventing the decline of, aquatic resources by an action in or near those aquatic resources. This term includes activities commonly associated with the protection and maintenance of aquatic resources through the implementation of appropriate legal and physical mechanisms. Preservation does not result in a gain of aquatic resource area or functions.

Re-establishment: The manipulation of the physical, chemical, or biological characteristics of a site with the goal of returning natural/historic functions to a former aquatic resource. Re-establishment results in rebuilding a former aquatic resource and results in a gain in aquatic resource area and functions.

Rehabilitation: The manipulation of the physical, chemical, or biological characteristics of a site with the goal of repairing natural/historic functions to a degraded aquatic resource. Rehabilitation results in a gain in aquatic resource function, but does not result in a gain in aquatic resource area.

Restoration: The manipulation of the physical, chemical, or biological characteristics of a site with the goal of returning natural/historic functions to a former or degraded aquatic resource. For the purpose of tracking net gains in aquatic resource area, restoration is divided into two categories: re-establishment and rehabilitation.

Riffle and pool complex: Riffle and pool complexes are special aquatic sites under the 404(b)(1) Guidelines. Riffle and pool complexes sometimes characterize steep gradient sections of streams. Such stream sections are recognizable by their hydraulic characteristics. The rapid movement of water over a coarse substrate in riffles results in a rough flow, a turbulent surface, and high dissolved oxygen levels in the water. Pools are deeper areas associated with riffles. A slower stream velocity, a streaming flow, a smooth surface, and a finer substrate characterize pools.

Riparian areas: Riparian areas are lands next to streams, lakes, and estuarine-marine shorelines. Riparian areas are transitional between terrestrial and aquatic ecosystems, through which surface and subsurface hydrology connects riverine, lacustrine, estuarine, and marine waters with their adjacent wetlands, non-wetland waters, or uplands. Riparian areas provide a variety of ecological functions and services and help improve or maintain local water quality. (See general condition 23.)

Shellfish seeding: The placement of shellfish seed and/or suitable substrate to increase shellfish production. Shellfish seed consists of immature individual shellfish or individual shellfish attached to shells or shell fragments (i.e., spat on shell). Suitable substrate may consist of shellfish shells, shell fragments, or other appropriate materials placed into waters for shellfish habitat.

Single and complete linear project: A linear project is a project constructed for the purpose of getting people, goods, or services from a point of origin to a terminal point, which often involves multiple crossings of one or more waterbodies at separate and distant locations. The term “single and complete project” is defined as that portion of the total linear project proposed or accomplished by one owner/developer or partnership or other association of owners/developers that includes all crossings of a single water of the United States (i.e., a single waterbody) at a specific location. For linear projects crossing a single or multiple waterbodies several times at separate and distant locations, each crossing is considered a single and complete project for purposes of NWP authorization. However, individual channels in a braided stream or river, or individual arms of a large, irregularly shaped wetland or lake, etc., are not separate waterbodies, and crossings of such features cannot be considered separately.

Single and complete non-linear project: For non-linear projects, the term “single and complete project” is defined at 33 CFR 330.2(i) as the total project proposed or accomplished by one owner/developer or partnership or other association of owners/developers. A single and complete non-linear project must have independent utility (see definition of “independent utility”). Single and complete non-linear projects may not be “piecemealed” to avoid the limits in an NWP authorization.

Stormwater management: Stormwater management is the mechanism for controlling stormwater runoff for the purposes of reducing downstream erosion, water quality degradation, and flooding and mitigating the adverse effects of changes in land use on the aquatic environment.

Stormwater management facilities: Stormwater management facilities are those facilities, including but not limited to, stormwater retention and detention ponds and best management practices, which retain water for a period of time to control runoff and/or improve the quality (i.e., by reducing the concentration of nutrients, sediments, hazardous substances and other pollutants) of stormwater runoff.

Stream bed: The substrate of the stream channel between the ordinary high water marks. The substrate may be bedrock or inorganic particles that range in size from clay to boulders. Wetlands contiguous to the stream bed, but outside of the ordinary high water marks, are not considered part of the stream bed.

Stream channelization: The manipulation of a stream’s course, condition, capacity, or location that causes more than minimal interruption of normal stream processes. A channelized jurisdictional stream remains a water of the United States.

Structure: An object that is arranged in a definite pattern of organization. Examples of structures include, without limitation, any pier, boat dock, boat ramp, wharf, dolphin, weir, boom, breakwater, bulkhead, revetment, riprap, jetty, artificial island, artificial reef, permanent mooring structure, power transmission line, permanently moored floating vessel, piling, aid to navigation, or any other manmade obstacle or obstruction.

Tidal wetland: A tidal wetland is a jurisdictional wetland that is inundated by tidal waters. Tidal waters rise and fall in a predictable and measurable rhythm or cycle due to the gravitational pulls of the moon and sun. Tidal waters end where the rise and fall of the water surface can no longer be practically measured in a predictable rhythm due to masking by other waters, wind, or other effects. Tidal wetlands are located channelward of the high tide line.

Tribal lands: Any lands title to which is either: 1) held in trust by the United States for the benefit of any Indian tribe or individual; or 2) held by any Indian tribe or individual subject to restrictions by the United States against alienation.

Tribal rights: Those rights legally accruing to a tribe or tribes by virtue of inherent sovereign authority, unextinguished aboriginal title, treaty, statute, judicial decisions, executive order or agreement, and that give rise to legally enforceable remedies.

Vegetated shallows: Vegetated shallows are special aquatic sites under the 404(b)(1) Guidelines. They are areas that are permanently inundated and under normal circumstances have rooted aquatic vegetation, such as seagrasses in marine and estuarine systems and a variety of vascular rooted plants in freshwater systems.

Waterbody: For purposes of the NWP's, a waterbody is a "water of the United States." If a wetland is adjacent to a waterbody determined to be a water of the United States, that waterbody and any adjacent wetlands are considered together as a single aquatic unit (see 33 CFR 328.4(c)(2)).

REGIONAL CONDITIONS:

The following Regional Conditions have been approved by the Wilmington District for the Nationwide Permits (NWP's) published in the January 13, 2021, *Federal Register* (86 FR 2744) announcing the reissuance of 12 existing (NWP's) and four new NWP's, as well as the reissuance of NWP general conditions and definitions with some modifications.

A. EXCLUDED WATERS AND/OR AREAS

The Corps has identified waters that will be excluded from the use of all NWP's during certain timeframes. These waters are:

1. **Anadromous Fish Spawning Areas**. Work in waters of the U.S. designated by either the North Carolina Division of Marine Fisheries (NCDMF) or the North Carolina

Wildlife Resources Commission (NCWRC) as anadromous fish spawning areas are prohibited from February 15th through June 30th, without prior written approval from the Corps and the appropriate wildlife agencies (NCDMF, NCWRC and/or the National Marine Fisheries Service (NMFS)). Work in waters of the U.S. designated by NCWRC as primary nursery areas in inland waters are prohibited from February 15th through September 30th, without prior written approval from the Corps and the appropriate wildlife agencies. Work in waters of the U.S. designated by NCDMF as primary nursery areas shall be coordinated with NCDMF prior to being authorized by this NWP. Coordination with NCDMF may result in a required construction moratorium during periods of significant biological productivity or critical life stages.

2. **Trout Waters Moratorium.** Work in waters of the U.S. in the designated trout watersheds of North Carolina are prohibited from October 15th through April 15th without prior written approval from the NCWRC, or from the Eastern Band of Cherokee Indians (EBCI) Fisheries and Wildlife Management (FWM) office if the project is located on EBCI trust land. (See Section C.3. above for information on the designated trout watersheds).

3. **Sturgeon Spawning Areas.** No in-water work shall be conducted in waters of the U.S. designated by the National Marine Fisheries Service as Atlantic sturgeon critical habitat from February 1st through June 30th. No in-water work shall be conducted in waters of the U.S. in the Roanoke River designated as Atlantic sturgeon critical habitat from February 1st through June 30th, and August 1st through October 31st, without prior written approval from NMFS.

4. **Submerged Aquatic Vegetation.** Impacts to Submerged Aquatic Vegetation (SAV) are not authorized by any NWP, except NWP 48, NWP 55 and NWP 56, unless Essential Fish Habitat (EFH) consultation has been completed pursuant to the Magnuson-Stevens Fisheries Conservation and Management Act (Magnuson-Stevens Act). Permittees shall submit a PCN (See NWP General Condition 32) to the District Engineer prior to commencing the activity if the project would affect SAV. The permittee may not begin work until notified by the Corps that the requirements of the Magnuson-Stevens Act have been satisfied and that the activity is verified.

B. REGIONAL CONDITIONS APPLICABLE TO ALL NWP's

1. **Critical Habitat in Western NC.** For proposed activities within waters of the U.S. that require a Pre-Construction Notification (PCN) and are located in the thirteen counties listed below, permittees must provide a copy of the PCN to the U.S. Fish and Wildlife Service (USFWS), 160 Zillicoa Street, Asheville, North Carolina 28801 and the Corps Asheville Regulatory Field Office. Please see General Condition 18 for specific PCN requirements related to the Endangered Species Act and the below website for information on the location of designated critical habitat.

Counties with tributaries that drain to designated critical habitat that require notification to the Asheville U.S. Fish and Wildlife Service: Avery, Cherokee, Graham, Haywood,

Henderson, Jackson, Macon, Mecklenburg, Mitchell, Swain, Transylvania, Union and Yancey.

Website and office addresses for Endangered Species Act Information:

The Wilmington District has developed the following website for permittees which provides guidelines on how to review linked websites and maps in order to fulfill NWP General Condition 18 (Endangered Species) requirements:

<http://www.saw.usace.army.mil/Missions/RegulatoryPermitProgram/AgencyCoordination/ESA.aspx>.

Permittees who do not have internet access may contact the appropriate U.S. Fish and Wildlife Service offices listed below or Corps at (910) 251-4850.

Below is a map of the USFWS Field Office Boundaries:

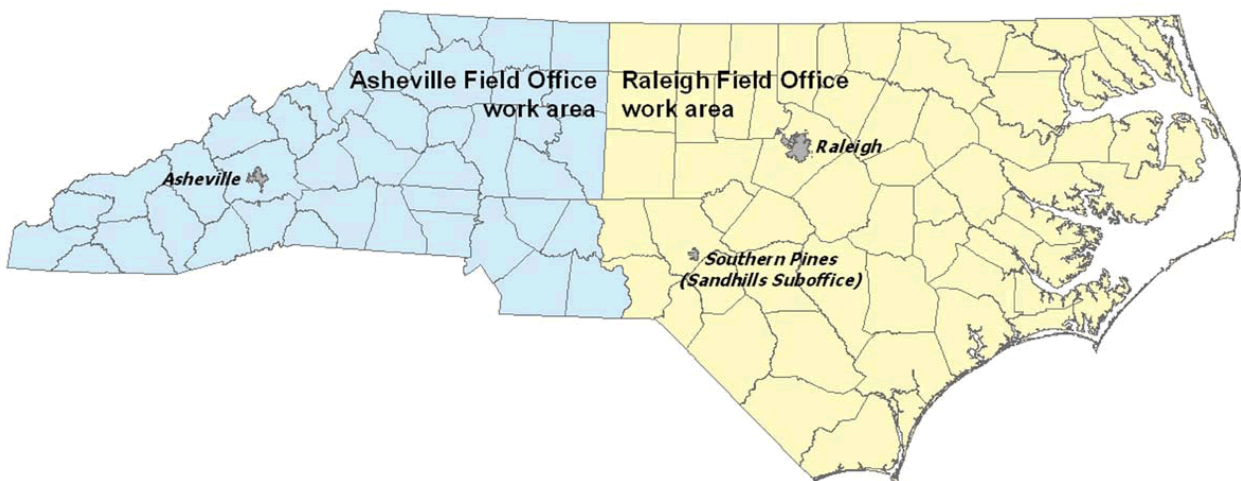

Asheville U.S. Fish and Wildlife Service Office counties: All counties west of and including Anson, Stanly, Davidson, Forsythe and Stokes Counties.

U.S. Fish and Wildlife Service
Asheville Field Office
160 Zillicoa Street
Asheville, NC 28801
Telephone: (828) 258-3939

Raleigh U.S. Fish and Wildlife Service Office counties: All counties east of and including Richmond, Montgomery, Randolph, Guilford, and Rockingham Counties.

U.S. Fish and Wildlife Service
Raleigh Field Office
Post Office Box 33726
Raleigh, NC 27636-3726

Telephone: (919) 856-4520

2. **Special Designation Waters.** Prior to the use of any NWP that involves a discharge of dredged or fill material in any of the following identified waters and/or adjacent wetlands in North Carolina, permittees shall submit a PCN to the District Engineer prior to commencing the activity (see General Condition 32). The North Carolina waters and wetlands that require additional PCN requirements are:

“Primary Nursery Areas” (PNA), including inland PNA, as designated by the North Carolina Marine Fisheries Commission and/or the North Carolina Wildlife Resources Commission. The definition of and designated PNA waters can be found in the North Carolina State Administrative Code at Title 15A, Subchapters 3R and 10C (15A NCAC 03R .0103; 15A NCAC 10C .0502; and 15A NCAC 10C .0503) and at the following web pages:

- <http://reports.oah.state.nc.us/ncac/title%2015a%20-%20environmental%20quality/chapter%2003%20-%20marine%20fisheries/subchapter%20r/15a%20ncac%2003r%20.0103.pdf>
- <http://reports.oah.state.nc.us/ncac/title%2015a%20-%20environmental%20quality/chapter%2010%20-%20wildlife%20resources%20and%20water%20safety/subchapter%20c/15a%20ncac%2010c%20.0502.pdf>
- <http://reports.oah.state.nc.us/ncac/title%2015a%20-%20environmental%20quality/chapter%2010%20-%20wildlife%20resources%20and%20water%20safety/subchapter%20c/15a%20ncac%2010c%20.0503.pdf>

3. **Trout Waters.** Prior to any discharge of dredge or fill material into streams, waterbodies or wetlands within the 294 designated trout watersheds of North Carolina, the permittee shall submit a PCN (see General Condition 32) to the District Engineer prior to commencing the activity. The permittee shall also provide a copy of the PCN to the appropriate NCWRC office, or to the EBCI FWM Office (if the project is located on EBCI trust land), to facilitate the determination of any potential impacts to designated Trout Waters.

NCWRC and NC Trout Watersheds:

NCWRC Contact**	Counties that are entirely within Trout Watersheds*	Counties that are partially within Trout Watersheds*
<p>Mountain Coordinator 645 Fish Hatchery Rd., Building B Marion, NC 28752 828-803-6054</p> <p>For NCDOT Projects:</p> <p>NCDOT Coordinator 12275 Swift Rd. Oakboro, NC 28129 704-984-1070</p>	<p>Alleghany Jackson Ashe Macon Avery Swain Graham Transylvania Haywood Watauga</p>	<p>Burke McDowell Buncombe Mitchell Caldwell Polk Cherokee Rutherford Clay Surry Henderson Wilkes Madison Yancey</p>
EBCI Contact**	Counties that are within Trout Watersheds*	
<p>Office of Natural Resources P.O. Box 1747, Cherokee, NC 28719 (828) 359-6113</p>	<p>Qualla Boundary and non-contiguous tracts of trust land located in portions of Swain, Jackson, Haywood, Graham and Cherokee Counties.</p>	

*NOTE: To determine PCN requirements, contact the Corps Asheville Regulatory Field Office at (828) 271-7980 or view maps showing trout watersheds in each County at the following webpage:

[http://www.saw.usace.army.mil/Missions/Regulatory-Permit-Program/Agency-Coordination/Trout/.](http://www.saw.usace.army.mil/Missions/Regulatory-Permit-Program/Agency-Coordination/Trout/)

**If a project is located on EBCI trust land, submit the PCN in accordance with Regional Condition C.16. Contact the Corps Asheville Regulatory Field Office at (828) 271-7980 with questions.

4. **Western NC Waters and Corridors.** The permittee shall submit a PCN (see General Condition 32) to the District Engineer prior to commencing the activity in waters of the U.S. if the activity will occur within any of the following identified waters in western North Carolina, within 0.5 mile on either side of these waters, or within 0.75 mile of the Little Tennessee River, as measured from the top of the bank of the respective water (i.e., river, stream, or creek):

Brasstown Creek
Burningtown Creek
Cane River
Caney Fork
Cartoogechaye Creek
Chattooga River
Cheoah River
Cowee Creek
Cullasaja River
Deep Creek
Ellijay Creek
French Broad River
Garden Creek
Hiwassee River
Hominy Creek
Iotla Creek
Little Tennessee River (within the river or within 0.75 mile on either side of this river)
Nantahala River
Nolichucky River
North Fork French Broad River
North Toe River
Nottley River
Oconaluftee River (portion not located on trust/EBCI land)
Peachtree Creek
Shooting Creek
Snowbird Creek
South Toe River
Stecoah Creek
Swannanoa River
Sweetwater Creek
Tuckasegee River (also spelled Tuckaseegee or Tuckaseigee)
Valley River
Watauga Creek
Watauga River
Wayah Creek

West Fork French Broad River

To determine PCN requirements, contact the Corps Asheville Regulatory Field Office at (828) 271-7980 or view maps for all corridors at the following webpage:

<http://www.saw.usace.army.mil/Missions/Regulatory-Permit-Program/Agency-Coordination/Designated-Special-Waters.aspx>.

5. **Limitation of Loss of Stream Bed.** NWP's may not be used for activities that may result in the loss of more than 0.05 acres of stream bed, except for NWP 32.

6. **Pre-Construction Notification for Loss of Stream Bed Exceeding 0.02 acres.**

The permittee shall submit a PCN to the District Engineer prior to commencing the activity (see General Condition 32) prior to the use of any NWP for any activity that results in the loss of more than 0.02 acres of stream bed. This applies to NWP's that do not have PCN requirements as well as those NWP's that require a PCN.

7. **Mitigation for Loss of Stream Bed.** For any NWP that results in a loss of more than 0.02 acres of stream bed, the permittee shall provide a mitigation proposal to compensate for more than minimal individual and cumulative adverse impacts to the aquatic environment, unless the District Engineer determines in writing that either some other form of mitigation would be more environmentally appropriate or the adverse effects of the proposed activity are minimal. For stream bed losses of 0.02 acres or less that require a PCN, the District Engineer may determine, on a case-by-case basis, that compensatory mitigation is required to ensure that the activity results in minimal adverse effect on the aquatic environment.

8. **Riprap.** For all NWP's that allow for the use of riprap material for bank stabilization, the following conditions shall be applied:

a. Filter cloth must be placed underneath the riprap as an additional requirement of its use in North Carolina waters. The placement of filter fabric is not required if the riprap will be pushed or "keyed" into the bank of the waterbody. A waiver from the specifications in this Regional Condition must be requested in writing.

b. Riprap shall be placed only on the stream banks, or, if it is necessary to be placed in the stream bed, the finished top elevation of the riprap should not exceed that of the original stream bed.

9. **Culvert Placement.** For all NWP's that allow for culvert placement, the following conditions shall be applied:

a. For all NWP's that involve the construction/installation of culverts, measures shall be included in the construction/installation that will promote the safe passage of fish and other aquatic organisms

Placement of culverts and other structures in streams shall be below the elevation of the streambed by one foot for all culverts with a diameter greater than 48 inches, and 20% of the culvert diameter for culverts having a diameter less than or equal to 48 inches. If the culvert outlet is submerged within a pool or scour hole and designed to provide for aquatic passage, then culvert burial into the streambed is not required.

Culvert burial is not required for structures less than 72 inch diameter/width, where the slope of the culvert will be greater than 2.5%, provided that all alternative options for flattening the slope have been investigated and aquatic life movement/connectivity has been provided when possible (e.g., rock ladders, cross vanes, sills, baffles etc.). Culvert burial is not required when bedrock is present in culvert locations.

Installation of culverts in wetlands shall ensure continuity of water movement and be designed to adequately accommodate high water or flood conditions. When roadways, causeways, or other fill projects are constructed across FEMA-designated floodways or wetlands, openings such as culverts or bridges shall be provided to maintain the natural hydrology of the system as well as prevent constriction of the floodway that may result in destabilization of streams or wetlands.

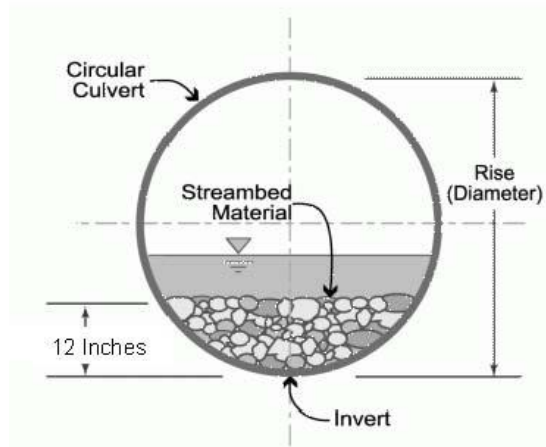

A waiver from the depth specifications in this condition may be requested, in writing, by the permittee and issued by the Corp. This waiver request must be specific as to the reasons(s) for the request. The waiver will be issued if it can be demonstrated that the proposed design would result in less impacts to the aquatic environment. Culverts placed across wetland fills purely for the purposes of equalizing surface water do not have to be buried, but the culverts must be of adequate size and/or number to ensure unrestricted transmission of water.

b. Bank-full flows (or less) shall be accommodated through maintenance of the existing bank-full channel cross sectional area. Additional culverts or culvert barrels at such crossings shall be allowed only to receive bank-full flows.

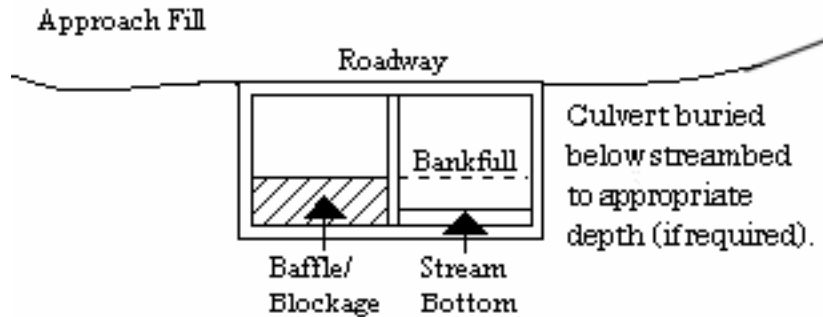

c. Culverts shall be designed and installed in such a manner that the original stream profiles are not altered and allow for aquatic life movement during low flows. The dimension, pattern, and profile of the stream above and below a pipe or culvert shall not be modified by widening the stream channel or by reducing the depth of the stream in connection with the construction activity. The width, height, and gradient of a proposed culvert shall be such as to pass the average historical low flow and spring flow without adversely altering flow velocity. If the width of the culvert is wider than the stream channel, the culvert shall include multiple boxes/pipes, baffles, benches and/or sills to maintain the natural width of the stream channel. If multiple culverts/pipes/barrels are used, low flows shall be accommodated in one culvert/pipe and additional culverts/pipes shall be installed such that they receive only flows above bankfull.

10. **Utility Lines.** For all NWP's that allow for the construction and installation of utility lines, the following conditions shall be applied:

a. Utility lines consisting of aerial electric power transmission lines crossing navigable waters of the U.S. (which are defined at 33 CFR part 329) must comply with the applicable minimum clearances specified in 33 CFR 322.5(i).

b. The work area authorized by this permit, including temporary and/or permanent fills, will be minimized to the greatest extent practicable. Justification for work corridors exceeding forty (40) feet in width is required and will be based on pipeline diameter and length, size of equipment required to construct the utility line, and other construction information deemed necessary to support the request. The permittee is required to provide this information to the Corps with the initial PCN package.

c. A plan to restore and re-vegetate wetland areas cleared for construction must be submitted with the required PCN. Cleared wetland areas shall be re-vegetated, as appropriate, with species of canopy, shrub, and herbaceous species. The permittee shall not use fescue grass or any other species identified as invasive or exotic species by the NC Native Plant Society (NCNPS): <https://ncwildflower.org/invasive-exotic-species-list/>.

d. Any permanently maintained corridor along the utility right of way within forested wetlands shall be considered a loss of aquatic function. A compensatory mitigation plan will be required for all such impacts associated with the requested activity if the activity requires a PCN and the cumulative total of permanent conversion of forested wetlands

exceeds 0.1 acres, unless the District Engineer determines in writing that either some other form of mitigation would be more environmentally appropriate or the adverse effects of the proposed activity are minimal.

Where permanently maintained corridor within forested wetlands is 0.1 acres or less, the District Engineer may determine, on a case-by-case basis, that compensatory mitigation is required to ensure that the activity results in minimal adverse effects on the aquatic environment.

e. When directional boring or horizontal directional drilling (HDD) under waters of the U.S., including wetlands, permittees shall closely monitor the project for hydraulic fracturing or “fracking.” Any discharge from hydraulic fracturing or “fracking” into waters of the U.S., including wetlands, shall be reported to the appropriate Corps Regulatory Field Office within 48 hours. Restoration and/or compensatory mitigation may be required as a result of any unintended discharges.

11. **Temporary Access Fills.** The permittee shall submit a PCN to the District Engineer prior to commencing the activity if the activity will involve the discharge of dredged or fill material into more than 0.1 acres of wetlands or 0.02 acres of stream channel for the construction of temporary access fills and/or temporary road crossings. The PCN must include a restoration plan that thoroughly describes how all temporary fills will be removed, how pre-project conditions will be restored, and include a timetable for all restoration activities.

12. **Federal Navigation Channel Setbacks.** Authorized structures and fills located in or adjacent to Federally authorized waterways must be constructed in accordance with the latest setback criteria established by the Wilmington District Engineer. You may review the setback policy at <http://www.saw.usace.army.mil/Missions/Navigation/Setbacks.aspx>. This general permit does not authorize the construction of hardened or permanently fixed structures within the Federally Authorized Channel Setback, unless the activity is approved by the Corps. The permittee shall submit a PCN (see General Condition 32) to the District Engineer to obtain a written verification prior to the construction of any structures or fills within the Federally Authorized Channel Setback.

13. **Northern Long-eared Bat – Endangered Species Act Compliance**

The Wilmington District, U.S. Army Corps of Engineers has consulted with the United States Fish and Wildlife Service (USFWS) in regard to the threatened Northern long-eared bat (NLEB) (*Myotis septentrionalis*) and Standard Local Operating Procedures for Endangered Species (SLOPES) have been approved by the Corps and the USFWS. This condition concerns effects to the NLEB only and does not address effects to other federally listed species and/or federally designated critical habitat.

A. Procedures when the Corps is the lead federal* agency for a project:

The permittee must comply with (1) and (2) below when:

- the project is located in the western 41 counties of North Carolina, to include non-federal aid North Carolina Department of Transportation (NCDOT) projects, OR;
- the project is located in the 59 eastern counties of North Carolina and is a non-NCDOT project.

*Generally, if a project is located on private property or on non-federal land, and the project is not being funded by a federal entity, the Corps will be the lead federal agency due to the requirement to obtain Department of the Army authorization to impact waters of the U.S. If the project is located on federal land, contact the Corps to determine the lead federal agency.

(1) A permittee using an NWP must check to see if their project is located in the range of the NLEB by using the following website: <http://www.fws.gov/midwest/endangered/mammals/nleb/pdf/WNSZone.pdf>. If the project is within the range of the NLEB, or if the project includes percussive activities (e.g., blasting, pile driving, etc.), the permittee is then required to check the appropriate website in the paragraph below to discover if their project:

- is located in a 12-digit Hydrologic Unit Code area (“red HUC” - shown as red areas on the map), AND/OR;
- involves percussive activities within 0.25 mile of a red HUC.

Red HUC maps - for the western 41 counties in NC (covered by the Asheville Ecological Services Field Office), check the project location against the electronic maps found at: http://www.fws.gov/asheville/htmls/project_review/NLEB_in_WNC.html. For the eastern 59 counties in NC (covered by the Raleigh Ecological Services Field Office), check the project location against the electronic maps found at: https://www.fws.gov/raleigh/NLEB_RFO.html.

(2) A permittee must submit a PCN to the District Engineer, and receive written verification from the District Engineer, prior to commencing the activity, if the activity will involve any of the following:

- tree clearing/removal and/or, construction/installation of wind turbines in a red HUC, AND/OR;
- bridge removal or maintenance, unless the bridge has been inspected and there is no evidence of bat use, (applies anywhere in the range of the NLEB), AND/OR;
- percussive activities in a red HUC, or within 0.25 mile of a red HUC.

The permittee may proceed with the activity without submitting a PCN to either the Corps or the USFWS, provided the activity complies with all applicable NWP terms and general and regional conditions, if the permittee’s review under A.(1) and A.(2) above shows that the project is:

- located outside of a red HUC (and there are no percussive activities), and the activity will NOT include bridge removal or maintenance, unless the bridge has been inspected and there is no evidence of bat use, OR;
- located outside of a red HUC and there are percussive activities, but the percussive activities will not occur within 0.25-mile of a red HUC boundary, and the activity will NOT include bridge removal or maintenance, unless the bridge has been inspected and there is no evidence of bat use, OR;
- located in a red HUC, but the activity will NOT include tree clearing/removal; construction/installation of wind turbines; bridge removal or maintenance, unless the bridge has been inspected and there is no evidence of bat use, and/or; any percussive activities.

B. Procedures when the USACE is not the lead federal agency:

For projects where another federal agency is the lead federal agency - if that other federal agency has completed project-specific ESA Section 7(a)(2) consultation for the NLEB, and has (1) determined that the project would not cause prohibited incidental take of the NLEB, and (2) completed coordination/consultation that is required by the USFWS (per the directions on the respective USFWS office's website), that project may proceed without PCN to either the USACE or the USFWS, provided all General and Regional Permit Conditions are met.

The NLEB SLOPES can be viewed on the USACE website at:

<http://www.saw.usace.army.mil/Missions/Regulatory-Permit-Program/Agency-Coordination/ESA/>. Permittees who do not have internet access may contact the USACE at (910) 251- 4633.

14. **West Indian Manatee Protection.** In order to protect the endangered West Indian manatee (*Trichechus manatus*) the Permittee shall implement the USFWS' Manatee Guidelines, and strictly adhere to all requirements therein. The guidelines can be found at <https://www.fws.gov/raleigh/pdfs/ManateeGuidelines2017.pdf>.

15. **ESA Programmatic Biological Opinions.** The Wilmington District, USFWS, NCDOT, and the FHWA have conducted programmatic Section 7(a)(2) consultation for a number of federally listed species and designated critical habitat (DCH), and programmatic consultation concerning other federally listed species and/or DCH may occur in the future. The result of completed programmatic consultation is a Programmatic Biological Opinion (PBO) issued by the USFWS. These PBOs contain mandatory terms and conditions to implement the reasonable and prudent measures that are associated with "incidental take" of whichever species or critical habitat is covered by a specific PBO. Authorization under NWP is conditional upon the permittee's compliance with all the mandatory terms and conditions associated with incidental take of the applicable PBO (or PBOs), which are incorporated by reference in the NWPs. Failure to comply with the terms and conditions associated with incidental take of an applicable PBO, where a take of the federally listed species occurs, would constitute an unauthorized take by the permittee, and would also constitute permittee

non-compliance with the authorization under the NWP. If the terms and conditions of a specific PBO (or PBOs) apply to a project, the Corps will include this/these requirements in any NWP verification that may be issued for a project. For an activity/project that does not require a PCN, the terms and conditions of the applicable PBO(s) also apply to that non-notifying activity/project. The USFWS is the appropriate authority to determine compliance with the terms and conditions of its PBO and the ESA. All PBOs can be found on our website at:

<https://www.saw.usace.army.mil/Missions/Regulatory-Permit-Program/Agency-Coordination/ESA/>.

16. Work on Eastern Band of Cherokee Land.

Notifying NWPs - All PCNs submitted for activities in waters of the U.S. on Eastern Band of Cherokee Indians (EBCI) trust land (i.e., Qualla Boundary and non-contiguous tracts of trust land located in portions of Swain, Jackson, Haywood, Graham and Cherokee Counties), must comply with the requirements of the latest MOU between the Wilmington District and the EBCI.

Non-notifying NWPs - Prior to the use of any non-notifying NWP for activities in waters of the U.S. on EBCI trust land (i.e., Qualla Boundary and non-contiguous tracts of trust land located in portions of Swain, Jackson, Haywood, Graham and Cherokee Counties), all prospective permittees must comply with the requirements of the latest MOU between the Wilmington District and the EBCI; this includes coordinating the proposed project with the EBCI Natural Resources Program and obtaining a Tribal Approval Letter from the Tribe.

The EBCI MOU can be found at the following URL: <http://saw-reg.usace.army.mil/FO/Final-MOU-EBCI-USACE.pdf>

17. Sedimentation and Erosion Control Structures and Measures

All PCNs will identify and describe sedimentation and erosion control structures and measures proposed for placement in waters of the U.S. The structures and measures should be depicted on maps, surveys or drawings showing location and impacts to jurisdictional wetlands and streams.

C. SECTION 401 WATER QUALITY CERTIFICATION (WQC) AND/OR COASTAL ZONE MANAGEMENT ACT (CZMA) CONSISTENCY DETERMINATION SUMMARY AND APPLICABLE CONDITIONS

The CZMA Consistency Determination and all Water Quality Certifications for the NWPs can be found at: <https://www.saw.usace.army.mil/Missions/Regulatory-Permit-Program/Permits/2017-Nationwide-Permits/>

NV Energy
Dewatering Approach for Underground Projects



NV Energy
Contact: Donald Thompson, NDPP
6100 Neil Rd, Reno, NV 89511
Donald.Thompson@nvenergy.com

(775) 834-3554



NV Energy Dewatering Plan for Underground Projects

INTRODUCTION

This Dewatering Plan applies to areas of high groundwater within northern Nevada. It will be the responsibility of the Contractor to submit a final dewatering plan that details means and methods for construction in full compliance with the requirements presented in this plan. It will be the goal of the Contractor and NV Energy to ensure protection of groundwater during excavations from potential contaminant releases during equipment use and refueling, such as specific spill control and clean up and response measures in the vicinity of excavations. This plan also discusses the requirements of the Contractor for collection and treatment of any groundwater prior to release.

TRAVEL ROUTE

If the area has delineated wetlands, the contractor shall be aware of the wetland locations and avoid them. The crews will travel along the trench alignment and remain within the right-of-way or easements. No vehicles shall enter the wetlands. No refueling shall be done in or near the wetlands.

DEWATERING

If required due to groundwater seeping into the trench, dewatering will be implemented to ensure safe and efficient trenching operations, to manage groundwater, and maintain dry working conditions. The primary dewatering method will include the use of sump pumps.

The use and location of sump pumps will be based on site-specific conditions, including trench depth, soil composition, and the volume of groundwater encountered. Water that seeps into the excavation will be collected in sumps and pumped from the trench to maintain a condition dry enough to allow for proper construction. This approach will minimize risks of instability, erosion, and flooding, ensuring the safety and integrity of the excavation process.

Water removed from the trench will be stored and discharged in a few different methods, depending on site conditions and local regulations. The specific method of storage and discharge will depend on factors such as water quality, volume, and permit requirements.

1. If the groundwater is free of contaminants including sediment, the water can be utilized on site for dust control.
2. If the groundwater contains sediment, all groundwater that is removed from the trench shall be filtered to remove sediment and discharged to stable upland areas or hauled offsite in a manner approved by the regulatory agencies. Collected sediment could be used to backfill the trench.
3. If groundwater could contain contaminants, the water may be hauled off-site for proper treatment and disposal in accordance with environmental, health, and local regulations.

The Contractor shall have on hand, at all times, sufficient pumping equipment, filter sleeves, hoses and machinery in good working condition and shall have available, at all times, competent personnel for the implementation of dewatering. Adequate standby equipment and supplies shall be kept available at all times to ensure efficient dewatering and maintenance of dewatering operation during power failure. The Contractor shall be responsible for designing and controlling the dewatering operations



such that disposal of water does not cause erosion or other damage. Settling basins and/or other means shall be used as necessary. The termination of dewatering operations shall be performed in such a manner as to maintain the undisturbed state of the natural soils, prevent disturbance of compacted backfill and prevent flotation or movement of structures.