

BENEFICIARY ELIGIBLE MITIGATION ACTION CERTIFICATION

Beneficiary _____

Lead Agency Authorized to Act on Behalf of the Beneficiary _____
(Any authorized person with delegation of such authority to direct the Trustee delivered to the Trustee pursuant to a Delegation of Authority and Certificate of Incumbency)

Action Title:	
Beneficiary's Project ID:	
Funding Request No.	<i>(sequential)</i>
Request Type: (select one or more)	<input type="checkbox"/> Reimbursement <input type="checkbox"/> Advance <input type="checkbox"/> Other (specify): _____
Payment to be made to: (select one or more)	<input type="checkbox"/> Beneficiary <input type="checkbox"/> Other (specify): _____
Funding Request & Direction (Attachment A)	<input type="checkbox"/> Attached to this Certification <input type="checkbox"/> To be Provided Separately

SUMMARY

Eligible Mitigation Action <input type="checkbox"/> Appendix D-2 item (specify): _____ Action Type <input type="checkbox"/> Item 10 - DERA Option (5.2.12) (specify and attach DERA Proposal): _____			
Detailed Description of Mitigation Action Item Including Community and Air Quality Benefits (5.2.2):			
Estimate of Anticipated NOx Reductions (5.2.3):			
Identification of Governmental Entity Responsible for Reviewing and Auditing Expenditures of Eligible Mitigation Action Funds to Ensure Compliance with Applicable Law (5.2.7.1):			
Describe how the Beneficiary will make documentation publicly available (5.2.7.2).			
Describe any cost share requirement to be placed on each NOx source proposed to be mitigated (5.2.8).			
Total project budget: \$ 278,948.25	Project costs paid by the Trust: \$ 27,329.24	Project costs paid by the NDEP: \$ 17,501.76	Cost share requirement: \$ 234,117.25
Describe how the Beneficiary complied with subparagraph 4.2.8, related to notice to U.S. Government Agencies (5.2.9).			
NDEP sent emails to the representatives from the U.S. Department of the Interior and the U.S. Department of Agriculture listed in subparagraph 4.2.8 of the State Trust Agreement on February 23, 2018.			

If applicable, describe how the mitigation action will mitigate the impacts of NOx emissions on communities that have historically borne a disproportionate share of the adverse impacts of such emissions (5.2.10).

ATTACHMENTS
(CHECK BOX IF ATTACHED)

- Attachment A Funding Request and Direction.
- Attachment B Eligible Mitigation Action Management Plan Including Detailed Budget and Implementation and Expenditures Timeline (5.2.4).
- Attachment C Detailed Plan for Reporting on Eligible Mitigation Action Implementation (5.2.11).
- Attachment D Detailed cost estimates from selected or potential vendors for each proposed expenditure exceeding \$25,000 (5.2.6). [Attach only if project involves vendor expenditures exceeding \$25,000.]
- Attachment E DERA Option (5.2.12). [Attach only if using DERA option.]
- Attachment F Attachment specifying amount of requested funding to be debited against each beneficiary's allocation (5.2.13). [Attach only if this is a joint application involving multiple beneficiaries.]

CERTIFICATIONS

By submitting this application, the Lead Agency makes the following certifications:

1. This application is submitted on behalf of Beneficiary _____, and the person executing this certification has authority to make this certification on behalf of the Lead Agency and Beneficiary, pursuant to the Certification for Beneficiary Status filed with the Court.
2. Beneficiary requests and directs that the Trustee make the payments described in this application and Attachment A to this Form.
3. This application contains all information and certifications required by Paragraph 5.2 of the Trust Agreement, and the Trustee may rely on this application, Attachment A, and related certifications in making disbursements of trust funds for the aforementioned Project ID.
4. Any vendors were or will be selected in accordance with a jurisdiction's public contracting law as applicable. (5.2.5)
5. Beneficiary will maintain and make publicly available all documentation submitted in

support of this funding request and all records supporting all expenditures of eligible mitigation action funds subject to applicable laws governing the publication of confidential business information and personally identifiable information. (5.2.7.2)

DATED: 7/15/22

Danilo Dragoni, PhD

[NAME]

[SIGNATURE]

Chief, Bureau of Air Quality Planning

[TITLE]

Nevada Division of Environmental Protection

[LEAD AGENCY]

for

Nevada

[BENEFICIARY]

**DETAILED DESCRIPTION OF MITIGATION ACTION ITEM INCLUDING
COMMUNITY AND AIR QUALITY BENEFITS (5.2.2)**

The Nevada Division of Environmental Protection (NDEP) is submitting this Eligible Mitigation Action Category 10 – DERA Option service vehicle replacement project to support the early retirement and replacement of one diesel-powered snowplow. The vehicle is owned and operated by the City of Reno and will be replaced with one brand-new diesel-powered snowplow, located within Washoe County, Nevada. Upon completion of this project, the permanent scrapping of one Government-owned service vehicle will provide a direct benefit to air quality.

The details regarding the individual unit being replaced through this project, as well as the replacement unit, are included on page 5 of this submission. The NDEP will work with the city on the scrapping of the program-eligible service vehicle and will coordinate with their staff for routine updates and possible site visits to ensure a timely and efficient completion of this project. The NDEP will not seek to have the city reimbursed for this project until they have provided sufficient scrapping evidence to the NDEP.

The total expected lifetime emissions reductions are provided in the table below. Emissions reductions were quantified using the EPA’s Diesel Emission Quantifier.¹

Pollutant	Emissions Reductions (tons)
NO _x	0.031
PM _{2.5}	0.004
CO	0.009
HC	0.005
CO ₂	134.055

¹ The EPA’s Diesel Emission Quantifier can be found online at <https://cfpub.epa.gov/quantifier/index.cfm?action=main.home>.

Fleet Information		#240602
CURRENT VEHICLE INFORMATION	Fiscal Year of EPA Funds Used:	2019
	Fleet Owner:	City of Reno Dept of Public Works
	Vehicle or Engine Group Type:	On Highway
	Primary Place of Performance	
	- State(s):	Nevada
	- County:	Washoe
	- City:	Reno
	- Zip Code:	Multiple zip codes in Reno, NV
	Target Fleet:	Short Haul - Single Unit
	Vehicle Class or Equipment Type:	8 (58,000 GVW)
	Quantity:	1
	Vehicle Identification Number(s):	1HTWXAXT64J091032
	Vehicle Make:	International
	Vehicle Model:	7600
	Vehicle Model Year:	2004
	Engine Serial Number(s):	3CRXH0729EBV
	Engine Make:	Caterpillar Inc.
	Engine Model:	C-12
	Engine Model Year:	2003
	Engine Tier:	II
	Engine Horsepower:	430
	Engine Cylinder Displacement:	11.9
	Engine Number of Cylinders:	6
	Engine Fuel Type:	Biodiesel 5
	Annual Amount of Fuel Used:	12,530
	Annual Usage Rate:	342
Annual Miles Traveled:	4,307	
Annual Idling Hours:	156	
Remaining Life:	1	
Normal Attrition Year:	2016	
NEW VEHICLE/UPGRADE INFORMATION	Year of Upgrade Action:	2023
	Upgrade Type:	Vehicle Replacement
	Upgrade:	Diesel
	Upgrade Cost Per Unit:	\$278,948.25
	Upgrade Labor Cost Per Unit:	\$0.00
	New Engine Model Year:	2023
	New Engine Tier:	4
	New Engine Horsepower:	430
	New Engine Cylinder Displacement:	14.9
	New Engine Number of Cylinders:	6
	New Engine Family Name:	Productivity Series
	New Engine Fuel Type:	Biodiesel 5
Annual Idling Hours:	156	
Annual Amount of Fuel Used:	615	

ATTACHMENT FOR 5.2.7.2

Describe how the Beneficiary will make documentation publicly available

Subparagraph 5.2.7.2 of the Environmental Mitigation Trust Agreement for State Beneficiaries requires that Beneficiaries include in their funding requests:

A commitment by the Beneficiary to maintain and make publicly available all documentation submitted in support of the funding request and all records supporting all expenditures of Eligible Mitigation Action funds, subject to applicable laws governing the publication of confidential business information and personally identifiable information, together with an explanation of the procedures by which the Beneficiary shall make such documentation publicly available;

The Nevada Division of Environmental Protection (NDEP), the Lead Agency for the State of Nevada, is committed to maintaining and making publicly available all documentation submitted support of the funding requests and all records supporting all expenditures of Eligible Mitigation Action funds, subject to applicable laws governing the publication of confidential business information and personally identifiable information.

The public will be able to view these records on the NDEP's website (<https://ndep.nv.gov>). The NDEP will maintain these records on a Volkswagen (VW) Environmental Mitigation Trust Fund specific webpage that will be designed to support public access and limit burden for the general public. The NDEP's VW specific webpage can currently be found at <https://ndep.nv.gov/air/vw-settlement>.

The NDEP has created an electronic listserv, open to the public, used to communicate news, events, and information related the Environmental Mitigation Trust Fund (Mitigation Fund). The listserv, NevadaVWFund, is advertised through the NDEP website and at public events related to the Mitigation Fund.

Chapters 603A and 239B of the Nevada Revised Statutes (NRS) provide definitions and requirements for handling *personal information*.

NRS Section 603A.040 defines 'Personal Information' as:

1. *"Personal information" means a natural person's first name or first initial and last name in combination with any one or more of the following data elements, when the name and data elements are not encrypted:*
 - (a) *Social security number.*
 - (b) *Driver's license number, driver authorization card number or identification card number.*
 - (c) *Account number, credit card number or debit card number, in combination with any required security code, access code or password that would permit access to the person's financial account.*
 - (d) *A medical identification number or a health insurance identification number.*

- (e) A user name, unique identifier or electronic mail address in combination with a password, access code or security question and answer that would permit access to an online account.*
- 2. The term does not include the last four digits of a social security number, the last four digits of a driver's license number, the last four digits of a driver authorization card number or the last four digits of an identification card number or publicly available information that is lawfully made available to the general public from federal, state or local governmental records.*

NRS Section 239B.030 – *Recorded, filed or otherwise submitted documents* - states that:

- 1. Except as otherwise provided in subsections 2 and 6, a person shall not include and a governmental agency shall not require a person to include any personal information about a person on any document that is recorded, filed or otherwise submitted to the governmental agency on or after January 1, 2007.*
- 2. If personal information about a person is required to be included in a document that is recorded, filed or otherwise submitted to a governmental agency on or after January 1, 2007, pursuant to a specific state or federal law, for the administration of a public program or for an application for a federal or state grant, a governmental agency shall ensure that the personal information is maintained in a confidential manner and may only disclose the personal information as required:*
- (a) To carry out a specific state or federal law; or*
- (b) For the administration of a public program or an application for a federal or state grant.*
- Any action taken by a governmental agency pursuant to this subsection must not be construed as affecting the legality of the document.*
- 3. A governmental agency shall take necessary measures to ensure that notice of the provisions of this section is provided to persons with whom it conducts business. Such notice may include, without limitation, posting notice in a conspicuous place in each of its offices.*
- 4. A governmental agency may require a person who records, files or otherwise submits any document to the governmental agency to provide an affirmation that the document does not contain personal information about any person or, if the document contains any such personal information, identification of the specific law, public program or grant that requires the inclusion of the personal information. A governmental agency may refuse to record, file or otherwise accept a document which does not contain such an affirmation when required or any document which contains personal information about a person that is not required to be included in the document pursuant to a specific state or federal law, for the administration of a public program or for an application for a federal or state grant.*
- 5. Each governmental agency may ensure that any personal information contained in a document that has been recorded, filed or otherwise submitted to the governmental agency before January 1, 2007, which the governmental agency continues to hold is:*
- (a) Maintained in a confidential manner if the personal information is required to be included in the document pursuant to a specific state or federal law, for the administration of a public program or for an application for a federal or state grant; or*
- (b) Obliterated or otherwise removed from the document, by any method, including, without limitation, through the use of computer software, if the personal information is not required to be*

included in the document pursuant to a specific state or federal law, for the administration of a public program or for an application for a federal or state grant.

↪ *Any action taken by a governmental agency pursuant to this subsection must not be construed as affecting the legality of the document.*

6. *A person may request that a governmental agency obliterate or otherwise remove from any document submitted by the person to the governmental agency before January 1, 2007, any personal information about the person contained in the document that is not required to be included in the document pursuant to a specific state or federal law, for the administration of a public program or for an application for a federal or state grant or, if the personal information is so required to be included in the document, the person may request that the governmental agency maintain the personal information in a confidential manner. If any documents that have been recorded, filed or otherwise submitted to a governmental agency:*

(a) Are maintained in an electronic format that allows the governmental agency to retrieve components of personal information through the use of computer software, a request pursuant to this subsection must identify the components of personal information to be retrieved. The provisions of this paragraph do not require a governmental agency to purchase computer software to perform the service requested pursuant to this subsection.

(b) Are not maintained in an electronic format or not maintained in an electronic format in the manner described in paragraph (a), a request pursuant to this subsection must describe the document with sufficient specificity to enable the governmental agency to identify the document.

↪ *The governmental agency shall not charge any fee to perform the service requested pursuant to this subsection.*

7. *As used in this section:*

(a) "Governmental agency" means an officer, board, commission, department, division, bureau, district or any other unit of government of the State or a local government.

(b) "Personal information" has the meaning ascribed to it in [NRS 603A.040](#).

Chapter 239 of the NRS provides general principles for the definition and the handling of public records. In particular, subsection 239.010.3 states that:

A governmental entity that has legal custody or control of a public book or record shall not deny a request made pursuant to subsection 1 to inspect or copy or receive a copy of a public book or record on the basis that the requested public book or record contains information that is confidential if the governmental entity can redact, delete, conceal or separate the confidential information from the information included in the public book or record that is not otherwise confidential.

Chapter 445B of the NRS (Air Controls) specifically provides further directions on what is confidential information and how such information must be handle in the context of the Air Program of the NDEP. In particular section 445B.570 – *Confidentiality and use of information obtained by Department*¹; penalty – states that (footnotes added for clarity):

¹ Nevada Department of Conservation and Natural Resources (DCNR)

1. *Any information which the Department obtains in the course of the performance of its duties pursuant to the provisions of this chapter is public information unless otherwise designated as confidential information pursuant to the provisions of this section.*
2. *The emission of an air contaminant which has an ambient air quality standard or emission standard or has been designated as a hazardous air pollutant by regulation of the Commission cannot be certified as being confidential.*
3. *Any confidential information received by the Commission², the Director³ or any local control authority which is certified in writing to the recipient as confidential by the owner or operator disclosing the information and verified and approved in writing as confidential by the recipient must, unless the owner expressly agrees to its publication or availability to the public, be used only:
 - (a) *In the administration or formulation of air pollution controls;*
 - (b) *In compiling or publishing analyses or summaries relating to the condition of the outdoor atmosphere which do not identify any owner or operator or reveal any confidential information;*or
 - (c) *In complying with federal statutes, rules and regulations.**
4. *This section does not prohibit the use of confidential information in a prosecution for the violation of any statute, ordinance or regulation for the control of air pollution.*
5. *A person who discloses or knowingly uses confidential information in violation of this section is guilty of a misdemeanor, and is liable in tort for any damages which may result from such disclosure or use.*
6. *As used in this section, "confidential information" means information or records which:
 - (a) *Relate to dollar amounts of production or sales;*
 - (b) *Relate to processes or production unique to the owner or operator; or*
 - (c) *If disclosed, would tend to affect adversely the competitive position of the owner or operator.**

² Nevada State Environmental Commission

³ Director of the Department of Conservation and Natural Resources

ATTACHMENT B

**ELIGIBLE MITIGATION ACTION MANAGEMENT PLAN INCLUDING DETAILED
BUDGET AND IMPLEMENTATION AND EXPENDITURES TIMELINE**

ATTACHMENT B

PROJECT MANAGEMENT PLAN PROJECT SCHEDULE AND MILESTONES

Milestones	Date
NDEP begins solicitation for project partners	CY 2021, Quarter 2
NDEP selects project partners	CY 2021, Quarter 2
NDEP submits Workplan and Budget Narrative to EPA	CY 2021, Quarter 3
EPA issues Notice of Award	CY 2021, Quarter 4
EPA Quarterly Report Due	CY 2022, Quarter 1
NDEP enters into Subgrant Agreements with identified project partners	CY 2022, Quarter 2
Project partners begin procurement of vehicles for replacement	CY 2022, Quarter 2
Project partners provide updates to the NDEP on the status of vehicle procurement and report on any delays in completing their projects	CY 2022, Quarter 2
EPA Quarterly Report Due	CY 2022, Quarter 2
Project partners provide updates to the NDEP on the status of vehicle procurement and report on any delays in completing their projects	CY 2022, Quarter 3
EPA Quarterly Report Due	CY 2022, Quarter 3
Project partners provide updates to the NDEP on the status of vehicle procurement and report on any delays in completing their projects	CY 2022, Quarter 4
EPA Quarterly Report Due	CY 2022, Quarter 4
Project partners provide updates to the NDEP on the status of vehicle procurement and report on any delays in completing their projects	CY 2023, Quarter 1
EPA Quarterly Report Due	CY 2023, Quarter 1
Project partners provide updates to the NDEP on the status of vehicle procurement and report on any delays in completing their projects	CY 2023, Quarter 2
Project partners begin to receive replacement vehicles	CY 2023, Quarter 2
Project partners begin to scrap vehicles being replaced	CY 2023, Quarter 2
EPA Quarterly Report Due	CY 2023, Quarter 2
NDEP verifies evidence of scrappage provided by project partners and performs drawdowns to reimburse partners for successful project completion	CY 2023, Quarter 3
EPA Quarterly Report Due	CY 2023, Quarter 3
Final Report due to EPA	CY 2023, Quarter 4

PROJECT BUDGET

Budget Category	Administrative Expenses	Share of Replacement Budget Funded by the Trust	Share of Replacement Budget Funded by DERA	Cost Share (Paid by Project Partner)	Subtotal
Administrative Expenditures					
Admin Expenditure Subtotal	\$ 0.00	-	-	-	\$ 0.00
Equipment Expenditures					
(1) International HX520 Heavy Duty Snowplow	-	\$ 27,329.24	\$ 17,501.76	\$ 234,117.25	\$ 278,948.25
Subtotal for Equipment Expenditures	-	\$ 27,329.24	\$ 17,501.76	\$ 234,117.25	\$ 278,948.25
Project Totals	\$ 0.00	\$ 27,329.24	\$ 17,501.76	\$ 234,117.25	\$ 278,948.25
Associated Percentages of Replacement Cost	-	10%	6%	84%	

PROJECTED TRUST ALLOCATIONS

ANNUAL PROJECTIONS	2023
1. Anticipated annual project funding request to be paid through the Trust	\$ 27,329.24
2. Portion of anticipated project funding request to be paid through the Trust to cover Eligible Mitigation Action Administrative Expenditures	\$ 0.00
3. Portion of anticipated project funding request to be paid through the Trust to cover Eligible Mitigation Action Expenditures	\$ 27,329.24
4. Anticipated annual cost share	\$ 251,619.01
5. Anticipated total project funding by year (line 1 plus line 4)	\$ 278,948.25
CUMULATIVE PROJECTIONS	
6. Cumulative outstanding Trustee payments requested against cumulative approved Beneficiary allocation	\$ 9,602,651.22
7. Cumulative Trustee payments made to date against cumulative approved Beneficiary allocation	\$ 12,079,440.45
8. Beneficiary funding to be paid through the Trust for this project (sum of line 1)	\$ 27,329.24
9. Total funding approved for Beneficiary Eligible Mitigation Actions, inclusive of current Action (sum of lines 6, 7, and 8)	\$ 21,709,420.90
10. Beneficiary share of estimated funds remaining in Trust	\$ 13,924,030.00
11. Estimated Beneficiary funds remaining in Trust after project completion (line 10 minus lines 6 and 8)	\$ 4,294,049.55

ATTACHMENT C

**DETAILED PLAN FOR REPORTING ON ELIGIBLE MITIGATION ACTION
IMPLEMENTATION**

ATTACHMENT C

DETAILED PLAN FOR REPORTING ON ELIGIBLE MITIGATION ACTION IMPLEMENTATION

The Nevada Division of Environmental Protection (NDEP) will provide detailed reporting on this Volkswagen (VW) Environmental Mitigation Trust Fund for State Beneficiaries Eligible Mitigation Action project in two ways: 1, timely updates to NDEP's VW Environmental Mitigation Trust Fund webpage; and 2, Nevada's semiannual reporting obligation to Wilmington Trust (the "Trustee").

NDEP maintains a VW Environmental Mitigation Trust Fund specific webpage that has been designed to support public access and limit burden for the general public. The NDEP's VW specific webpage can currently be found at <https://ndep.nv.gov/air/vw-settlement>. Timely updates to the webpage will inform the general public on the project's status as well as when this Eligible Mitigation Action has been completed.

Subparagraph 5.3 of the Environmental Mitigation Trust Agreement for State Beneficiaries details Nevada's Reporting Obligations:

"For each Eligible Mitigation Action, no later than six months after receiving its first disbursement of Trust Assets, and thereafter no later than January 30 (for the preceding six-month period of July 1 to December 31) and July 30 (for the preceding six-month period of January 1 to June 30) of each year, each Beneficiary shall submit to the Trustee a semiannual report describing the progress implementing each Eligible Mitigation Action during the six-month period leading up to the reporting date (including a summary of all costs expended on the Eligible Mitigation Action through the reporting date). Such reports shall include a complete description of the status (including actual or projected termination date), development, implementation, and any modification of each approved Eligible Mitigation Action. Beneficiaries may group multiple Eligible Mitigation Actions and multiple sub-beneficiaries into a single report. These reports shall be signed by an official with the authority to submit the report for the Beneficiary and must contain an attestation that the information is true and correct and that the submission is made under penalty of perjury. To the extent a Beneficiary avails itself of the DERA Option described in Appendix D-2, that Beneficiary may submit its DERA Quarterly Programmatic Reports in satisfaction of its obligations under this Paragraph as to those Eligible Mitigation Actions funded through the DERA Option. The Trustee shall post each semiannual report on the State Trust's public-facing website upon receipt."

NDEP shall, in the next semiannual report following the Trustee's approval of this project, describe the progress implementing this Eligible Mitigation Action that will include a summary of all costs expended on the Eligible Mitigation Action through the reporting date. The report will also include a complete description of the status, development, implementation (including project schedule and milestone updates), and any modification to this Eligible Mitigation Action.

ATTACHMENT D

**DETAILED COST ESTIMATES FROM SELECTED OR POTENTIAL VENDORS FOR
EACH PROPOSED EXPENDITURE EXCEEDING \$25,000**

Ship To

P.O. Box 1900
1640 E. Commercial Row
Corporation Yard
RENO, NV 89501

Bill To

P.O. Box 1900
1 East First Street
Ninth Floor
RENO, NV 89505

Purchase Order
No. 2022-00000491

DATE 01/20/2022

VENDOR NO. 8334

Vendor

HENDERSON PRODUCTS INC
28401 NETWORK PLACE
CHICAGO, IL 60673

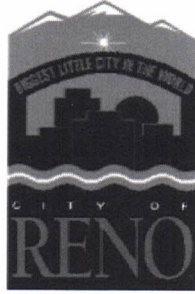

PURCHASE ORDER NUMBER MUST APPEAR ON ALL INVOICES, SHIPPERS, BILL OF LADING AND CORRESPONDENCE

DELIVER BY
SHIP VIA
FREIGHT TERMS
PAGE 1 of 1
ORIGINATOR: Haffner, Zac

REFERENCE #

QUANTITY	UNIT	DESCRIPTION	UNIT COST	TOTAL COST
4.0000	Each	FEES - DMV Title Fee 50000-1200-1216-7640-0000 - Machinery, Equipt, Furniture and Fixtures 113.00	28.2500	\$113.00
4.0000	Each	VEHICLES - HEAVY DUTY TRUCKS - 2023 International HX520 6X4 C/C w/Henderson Plow & Muni Body Truck and body to be painted white - Cab/Chassis build/spec to match proposal 4211-01 from Silver State International with an 80 gallon fuel tank - Snow Plow body and upfit to match build/spec of Henderson Products, Inc. quote #152275. 50000-1200-1216-7640-0000 - Machinery, Equipt, Furniture and Fixtures 1,115,680.00	278,920.0000	\$1,115,680.00
			TOTAL DUE	\$1,115,793.00

APPROVED BY/TITLE

RECEIVED BY

Special Instructions

Purchase 4 International HX520 with Henderson Body/Build Snow Plows for PW-Streets to replace #240601, #240602, #240603, and #240604. Purchase approval by City Council on 8/25/21 under item B.7 and these are being purchased utilizing the national Sourcewell contract. These vehicles will need further outfitting of a fuel tag (\$500) and decals.



HENDERSON

CUSTOMER QUOTE

PRODUCTS, INC.

11921 SMITH DRIVE
HUNTLEY, IL 60142
PHONE: 847-836-4996
FAX: 563-927-7108

Page 1
Quote #152275
Rev #22

To: Silver Star International
Attn: Bo Burgarello
Quote Date: 11/22/2021
Valid Until: 12/22/2021

Quoted By: Doug Frauenholtz
Phone: 563-927-2828
Cell: 563-929-0071
Fax: 563-927-2521
Email: dfrauenholtz@hendersonproducts.com

Quoted:
Muni II with cross conveyor, Plow, and Prewet

Henderson Products is pleased to present the following quote. Please contact us if you have any questions.

Installation Workup

Facility: **IDC-IL**
Chassis Delivery To Henderson: **Truck Dealer/Customer Delivers**
Completed Truck Delivery Method: **Drive-Away Service**
Completed Truck Delivery Method Notes: **Delivered to Reno**
Chassis Make: **International**
Chassis Model Yr: **2020**
Chassis Model: **HV**
Useable CA/CT: **136**
Front Axle Rating: **18000**
Rear Axle Rating: **46000**
Front Frame Ext?: **Yes**
Frnt Frame Ext Type: **Full**
Front Frame Wall: **Single Wall**
Front Frame Width: **34"**
Pump Location: **Front Mount Pump (REQUIRES FRONT CRANKSHAFT PROVISION)**
Transmission Type: **Automatic**
Transmission Model: **Allison Transmission**

Hitch Type: **Flat Plate Hitch**
Mount Type: **Tailpiece Kit (Select Type Below)**
Front Bumper: **Fabricated Channel Bumper (2pc design) (MFG Material)**

Front Plow Type: **Standard Henderson Plow**
Plow Markers (Front Plow): **IDC Install of fact supplied markers, sales to order w/ unit**
Rubber Deflector Install: **Supplied/Installed @ Factory, sales to order w/ unit**

Dump Body Type: **Munibody II (Std/FF)**
Floor Length: **16ft Floor Length**
Hoist Type: **Tele Trun Hoist, Ext Dhouse, add's 1' overall**
Cylinder Type: **Double Acting**
Discharge Type: **Frnt Cross Conveyor Discharge Only**
Spinner Assembly Location: **Front or Rear Mounted Spinner Assembly (single spinner)**
Body Material (Sides/ends): **Stainless Steel Type Body Material**

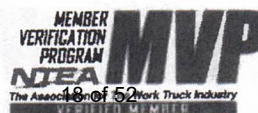



HENDERSON

PRODUCTS, INC.

11921 SMITH DRIVE
HUNTLEY, IL 60142
PHONE: 847-836-4996
FAX: 563-927-7108

CUSTOMER QUOTE

Page 2
Quote #152275
Rev #22

Tailgate Release Type: **IDC supplied Electric over air valve**
Pressure Protection Valve: **Direct to air tank valve (Int, Mack & Volvo)**
Cabshield Install: **Supl'd by fact, welded to body @ IDC, sales to order w/ unit**
Ladder(s): **Supplied by factory, Install @ IDC (sales to order w/ unit)**
Ladder Install QTY (Dump): **(1) LADDER INSTALLED @ IDC (LABOR ONLY)**
Ladder Install Style (Dump) 1: **Fold Down Side Ladder**
Ladder Install Loc 1 (Dump): **Driver Side Front**
Shovel Holder: **(1) IDC Supl'd Spring Loaded SS Shovel Holder w/ SS brckt**
Shovel Holder Loc (1): **Driver side headsheet**

Body Spec Notes:

Prewet/Liquid System: **Muni/BBMAXX Prewet System**
Drive Configuration: **Hydraulic Drive, Henderson Supplied (Sales to order w/unit)**
Controls: **Supplied by IDC (sales to order w/ hyd cntrls)**
Feedback Sensor: **Factory Supplied/Installed (Sales to order w/unit)**
Flush Kit: **Supplied by factory, Installed @ IDC (sales to order w/unit)**
Pwet Discharge Loc: **Front or Rear Spinner Only**

Liquid Details:

Chassis Accessories: **Yes (SELECT RELATED OPTIONS BELOW)**
Mudflaps (Rear): **Stationary w/Logo**
Mudflap Type (Rear): **36" Stationary, SS FF Muni Body (with LOGO)**
Fenders: **Front Quarter Fenders, Poly (standard)**
Pintle Plate: **Yes (select from options below)**
Pintle Plate Configuration: **3/4" Plate, 25T, No Lights (w/3LTC)**
Pintle Plate D-Rings: **Qty (2) 3/4" D-rings**
Pintle Hook: **25 Ton, Swivel Type**
Tow Hooks: **Tow Hooks, 44,000 lb, PAIR (installed rear of chassis)**
Glad Hands: **Glads, Swing, 90 deg, Serv & Emerg, built in dust covers, Pr**
Trailer Plug (1): **7 Pin Trailer Plug, Truck end 7-Way RV, new style (municipal)**
Tool Box: **Qty 2 Toolbox (Select type below)**
Toolbox (1) Type: **18"x18"x36" Alum Tbox, Ub, T-handl, SS Brkts**
Tool Box Location 1: **Passenger side**
Toolbox (2) Type: **18"x18"x30" Alum Tbox, UB, T-handle, SS Brkts**
Tool Box Location 2: **Passenger side**
Truck Wash: **Complete Truck Wash/Clean/Vac 1**
Warranty: **Standard 1 Year Warranty**
Training: **Yes, Training Required**
Install Touch-up: **Basic Installation Touch-Up**

Electrical: **Yes (SELECT RELATED OPTIONS BELOW)**
Power Distribution Panel: **Power Distribution Panel**
Misc Electrical Supplies: **Req'd Misc Elect Supplies**
Plow Lights: **Plow Lts, Halogen, Trucklite All Chassis, (PAIR)**
Plow Light Brackets: **Plow Lt Hood Brckts, SS, INTERNATIONAL**





HENDERSON

PRODUCTS, INC.

11921 SMITH DRIVE
HUNTLEY, IL 60142
PHONE: 847-836-4996
FAX: 563-927-7108

CUSTOMER QUOTE

Page 3
Quote #152275
Rev #22

Worklight(s) QTY: **(QTY 1) Work Light (Select type below)**
Worklight (1) Type: **Flood Light, ABL, 2500 Led**
Worklight (1) Gen Location: **Front Spinner**
Cab Beacon: **LED Mini Ltbar, 201SS Stationary Mntng Brkct, Top Mnt**
Rear Dump Bolster (S/T/T): **LED S/T/T, kit (West) (order holes)**
OEM Light Remount: **Remount OEM Chassis Lights**
Rear Dump Bolster (Back-up): **B/U Lights, LED, Clear, Oval, pair (Order holes with body)**
Rear Dump Bolster Strobes: **6" LED Oval Strobes, Amber, 1 PR, (order holes w/unit)**
Back up alarm: **Backup Alarm, 102db**
Body up switch/light: **Body UP Switch/Body Up Light (Trucklite)**
Brake controller: **Brake Controller, Voyager Brake Controller**
Backbone & Wire Standoffs: **14' Backbone (For TA)**
Camera: **Zone Defense**
Camera Kit: **Camera Sys, 7" Color Monitor, Heated**
Pavement Temp Sensor: **Included w/ Hyd (price w/hyd pkg)**

Electrical Spec Notes:

Hydraulics: **Full Hydraulic Package**
Hyd Supplier: **Force America (Select Pkg Below)**
Hyd Supplier (Spec): **QTool-1231076-2**
Controls Type: **Electric Controls**
Reservoir Type: **Supplied With Hydraulics**
Reservoir Spec:
Valve Enclosure Type: **Supplied With Hydraulics**
Low Oil Shut Down: **Yes, included in Hyd Pkg**
High Temp Oil Shut Down: **Yes, included in Hyd Pkg**
Low Oil Indicator: **Yes, included in Hyd Pkg**
Return Filter: **Provided with Hydraulics**
SS Tubing Upgrade: **TA, F&R lines, 6' Frnt, 9' Rr**
Quick Coupler Upgrade: **Standard Quick Couplers**

Hydraulics Notes:

Reversible snow plow

Plow Length: **11' length**
Moldboard Trip: **Full trip with 2 external compression springs**
Pushframe Type: **Standard Circle Frame with Top Mount Cylinders**
Moldboard Height: **42" height**
Moldboard Shield: **Standard shield**
Moldboard Sheet Material: **10 GA GR50 steel (standard)**
Hydraulic Cylinders: **3" x 1 1/2" x 10" reversing nitrided cylinders**
Paint: **Henderson Orange**





HENDERSON

PRODUCTS, INC.

11921 SMITH DRIVE
HUNTLEY, IL 60142
PHONE: 847-836-4996
FAX: 563-927-7108

CUSTOMER QUOTE

Page 4
Quote #152275
Rev #22

12" Rubber Deflector: **Yes, w/ SS Backer**
Install Rubber Deflector: **Yes**
36" Plastic Side Markers, Pair: **Yes**
Cutting Edge: **3/4" x 6" Carbide cutting edge with cover blade**
Hitch, Truck Portion: **See HPH or HCH for Truck portion hitch**
Custom Option Fields: **Note Custom Details Below**
Option 1 Description: **Parallelogram style plow and truck side hitch**
Option 2 Description:
Option 3 Description:
Option 4 Description:
Option 5 Description:
Option 6 Description:

MUNIBody II multi-task body

Discharge Options: **Front Cross Conveyor with Front Discharge Only**
Doghouse Type: **Partial Internal Doghouse with Sloped Headsheet**
Body Length: **16' body length, 36" sides, 48" tailgate**
Side Height: **36" High Sides with pockets for 12" boards**
Side to Floor Transition: **35 Degree Slope from Horizontal on Sides**
Tailgate/Rear Body Style: **Standard Rear Discharge Apron 48" Tailgate**
Granular Capacity: **9.0 yd Sides 13.8 yd Ends**
Cabshield: **Yes**
Sides / Ends: **Optional 304SS sides, ends**
Floor: **1/4" AR400**
Cabshield Material: **10 ga. with 7 ga. endplates, Stainless Steel**
Cabshield Size: **22" X 84" (1/2 cab) 304SS**
Rear Apron / Bolsters: **304 Stainless Steel**
Tailgate Bracing: **304 Stainless Steel**
Body Hinge Type: **Greaseless Composite Bushing Hinge Blocks (I)**
Body Hinge Paint: **Yes, Rear Hinge Painted @ Factory**
Conveyor Motor with Integral Speed Sensor: **Yes**
Conveyor Motor and Gearcase Location: **Front Mounted Motor and Gearcase**
3/16" AR 400 Steel Conveyor Cover: **Yes, shipped loose**
Hydraulic Reservoir: **None, deduct from price**
Fold-up Side Ladder: **Yes**
Ladder Material: **10 ga. 304 SS**
Lighting Package: **LED lights**
Extra Light Holes in Rear Bolster: **Two extra light holes in each bolster**
Drivers Side Fender: **Platform Fenders for Toolbox or Tanks**
Passengers Side Fender: **Platform Fenders for Toolbox or Tanks**
Drivers Side Fender Accessory: **230 gallon poly tank (129.5 in long)**
Special Fender Options - Drivers Side: **None needed**
Passengers Side Fender Accessory: **230 gallon poly tank (129.5 in long)**
Special Fender Options - Passengers Side: **None needed**
Option 1 Description: **201SS ILO 304SS**
Option 2 Description: **REMOVE LED LIGHTS SUPPLIED BY INSTALL**
Option 3 Description: **REMOVE TAILGATE RELEASE VALVE SUPPLIED BY INSTALL**





HENDERSON

PRODUCTS, INC.

11921 SMITH DRIVE
HUNTLEY, IL 60142
PHONE: 847-836-4996
FAX: 563-927-7108

CUSTOMER QUOTE

Page 5
Quote #152275
Rev #22

Option 4 Description: **additional discount**

PWS liquid pre-wetting system

Power Source: **Hydraulic Powered Pump**
Application: **Munibody**
Product Size: **Munibody 14ft or Longer Cross Conveyor**
Control Box: **No Valve, Hydraulic Powered Pump and Flow Meter**
Pump: **Standard 4.1 GPM Bronze Gear Pump**
Console: **None-Deduct PWSH-I Console**
Tank Size: **No Tank(s)-Deduct MUNI 75 gal tank**
Spray Assembly: **Std Variable Displacement Nozzle Assembly for Rear Chute**
Prewet Installed: **Installation on MUNIBody**
Mounting Hardware: **No Mounting Hardware or N/A**
Flush Kit: **System flush kit**
Option 1 Description: **Pre-wet for FDO w/ cross conveyor. Driver side discharge**

Sourcewell Price includes International chassis per the attached specifications

Single Package: \$278,920.00
Package(s) : 4
Total: \$1,115,680.00

Sales tax may apply to this order but is not included in the package total. If you are tax exempt, please submit your exemption certificate to finance@hendersonproducts.com.

Due to current raw material market conditions this quote includes a surcharge on Henderson equipment. Quotes exceeding the expressed quote validity date are subject to surcharge revisions.

Signed: _____ Date: _____

Quote notes:

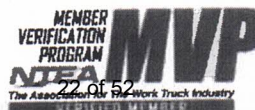

Prepared For:
 Reno, City of
 Zac Haffner
 1640 E. Commercial Row
 Reno, NV 89505-
 (702)334 - 2256
 Reference ID: N/A

Presented By:
 SILVER STATE INTL
 Bo Burgarello
 2255 LARKIN CIRCLE
 SPARKS NV 89431 -
 (775)685-6000

Thank you for the opportunity to provide you with the following quotation on a new International truck. I am sure the following detailed specification will meet your operational requirements, and I look forward to serving your business needs.

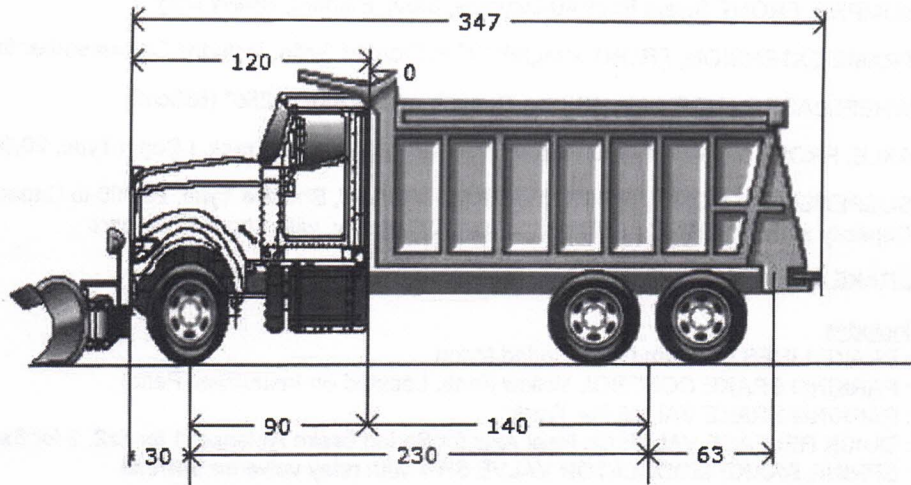

Model Profile
2023 HX520 SFA (HX520)

- AXLE CONFIG:** 6X4
- APPLICATION:** Front Plow with spreader
- MISSION:** Requested GVWR: 66000. Calc. GVWR: 58180. Calc. GCWR: 125000
 Calc. Start / Grade Ability: 22.38% / 2.52% @ 55 MPH
 Calc. Geared Speed: 81.3 MPH
- DIMENSION:** Wheelbase: 230.00, CA: 140.00, Axle to Frame: 63.00
- ENGINE, DIESEL:** {Cummins X15 430 V} Productivity Series, EPA 2021, 430HP @ 1900 RPM, 1650 lb-ft Torque @ 950 RPM, 2000 RPM Governed Speed, 441 Peak HP (Max)
- TRANSMISSION, AUTOMATIC:** {Allison 4000 RDS} 5th Generation Controls, Close Ratio, 6-Speed with Double Overdrive, with PTO Provision, Less Retarder, Includes Oil Level Sensor, On/Off Highway
- CLUTCH:** Omit Item (Clutch & Control)
- AXLE, FRONT NON-DRIVING:** {Meritor MFS-20-133A} Wide Track, I-Beam Type, 20,000-lb Capacity
- AXLE, REAR, TANDEM:** {Meritor MT-40-14X-4DCR-P} Single Reduction, 40,000-lb Capacity, with Lube Oil Pump, .433"(11mm) Wall Housing Thickness, Driver Controlled Locking Differential in Forward-Rear and Rear-Rear Axle, R Wheel Ends Gear Ratio: 4.63
- CAB:** Conventional, Day Cab
- TIRE, FRONT:** (2) 315/80R22.5 Load Range L G751 MSA (GOODYEAR), 484 rev/mile, 68 MPH, All-Position
- TIRE, REAR:** (8) 11R22.5 Load Range G HSR2 (CONTINENTAL), 498 rev/mile, 75 MPH, All-Position
- SUSPENSION, REAR, TANDEM:** {Hendrickson HMX EX 400} Walking Beam, 40,000-lb Capacity, 54" Axle Spacing, Rubber Springs, with Transverse Torque Rods, Rubber End Bushings
- PAINT:** Cab schematic 100LY
 Location 1: 9219, Winter White (Std)
 Chassis schematic N/A

<u>Code</u>	<u>Description</u>
HX52000	Base Chassis, Model HX520 SFA with 230.00 Wheelbase, 140.00 CA, and 63.00 Axle to Frame.
1AMS	CROSSMEMBER, FRAME TIE for Heavy Duty
1AND	AXLE CONFIGURATION {Navistar} 6x4
	<u>Notes</u>
	: Pricing may change if axle configuration is changed.
1CGD	FRAME RAILS Heat Treated Alloy Steel (120,000 PSI Yield); 12.50" x 3.750" x 0.500" (317.5mm x 95.25mm x 12.7mm); 480.8" (12212mm) Maximum OAL
1LLW	BUMPER, FRONT Swept Back 40-Degrees, Steel, Painted, Heavy Duty
1WCP	FRAME EXTENSION, FRONT Integral; 27" in Front of Grille, Includes Crossmember for Front PTO
1WXD	WHEELBASE RANGE 211" (535cm) Through and Including 256" (650cm)
2ARY	AXLE, FRONT NON-DRIVING {Meritor MFS-20-133A} Wide Track, I-Beam Type, 20,000-lb Capacity
3AEX	SUSPENSION, FRONT, SPRING Two Stage Multileaf, Shackle Type, 20,000-lb Capacity, Steel Springs 18K Capacity and (2) Rubber Auxiliary Springs 2K Capacity, with Shock Absorbers
4091	BRAKE SYSTEM, AIR Dual System for Straight Truck Applications
	<u>Includes</u>
	: BRAKE LINES Color and Size Coded Nylon
	: PARKING BRAKE CONTROL Yellow Knob, Located on Instrument Panel
	: PARKING BRAKE VALVE For Truck
	: QUICK RELEASE VALVE On Rear Axle for Spring Brake Release: 1 for 4x2, 2 for 6x4
	: SPRING BRAKE MODULATOR VALVE SR-7 with relay valve for 6x4/8x6
4619	TRAILER CONNECTIONS Four-Wheel, with Hand Control Valve and Tractor Protection Valve, for Straight Truck
4AZJ	AIR BRAKE ABS {Bendix AntiLock Brake System} 4-Channel (4 Sensor/4 Modulator) Full Vehicle Wheel Control System, with Automatic Traction Control
4EDM	AIR DRYER {Bendix AD-HF} with Heater, Includes Pressure Protection Circuits, Safety Valve, Integral Purge Tank, Governor Pressure Settings 110 psi Cut-In/130 psi Cut-Out, Integrated PuraGuard Coalescing Filtration
4EXU	BRAKE CHAMBERS, REAR AXLE {Bendix EverSure} 30/30 SqIn Spring Brake
4EXV	BRAKE CHAMBERS, FRONT AXLE {Bendix} 24 SqIn
4LAG	SLACK ADJUSTERS, FRONT {Gunite} Automatic
4LGG	SLACK ADJUSTERS, REAR {Gunite} Automatic
4SPA	AIR COMPRESSOR {Cummins} 18.7 CFM
4VKC	AIR DRYER LOCATION Mounted Inside Left Rail, Back of Cab
4VKK	AIR TANK LOCATION (2) Mounted Under Battery Box, Outside Right Rail, Back of Cab, Perpendicular to Rail
4WBX	DUST SHIELDS, FRONT BRAKE for Air Cam Brakes
4WDM	DUST SHIELDS, REAR BRAKE for Air Cam Brakes
4WXR	DRAIN VALVE (2) {Berg} with Pull Chains, for Air Tanks
4XDL	BRAKES, FRONT {Bendix Spicer ES-165-6X} Air S-Cam Type, Heavy Duty Fabricated Spider, Fabricated Shoe, Single Anchor Pin, Size 16.5" X 6", 23,000-lb Capacity
4XDM	BRAKES, REAR {Bendix Spicer ES-165-7X} Air S-Cam Type, Heavy Duty Fabricated Spider, Fabricated Shoe, Single Anchor Pin, Size 16.5" X 7", 23,000-lb Capacity per Axle

<u>Code</u>	<u>Description</u>
4XEE	PARK BRAKE CHAMBERS, ADDITIONAL (2) Spring Brake Type
5710	STEERING COLUMN Tilting and Telescoping
5CAW	STEERING WHEEL 4-Spoke; 18" Dia., Black
5PUB	STEERING GEAR (2) {Sheppard M100/HD94} Dual Power
6DGU	DRIVELINE SYSTEM {Dana Spicer} SPL250 Main Driveline with SPL170 Interaxle Shaft, for 6x4
7BEU	AFTERTREATMENT COVER Aluminum
7BLY	EXHAUST SYSTEM Horizontal Aftertreatment System, Frame Mounted Right Side Under Cab, for Single Vertical Tail Pipe, Cab Mounted Right Side
7SAP	ENGINE COMPRESSION BRAKE {Cummins} Interbrake For Cummins Signature/ISX/X15 Engines; Furnished with Engine
7WAZ	TAIL PIPE (1) Turnback Type
7WBS	MUFFLER/TAIL PIPE GUARD (1) Bright Stainless Steel
7WDM	EXHAUST HEIGHT 10'
8000	ELECTRICAL SYSTEM 12-Volt, Standard Equipment
	<u>Includes</u>
	: HAZARD SWITCH Push On/Push Off, Located on Instrument Panel to Right of Steering Wheel
	: HEADLIGHT DIMMER SWITCH Integral with Turn Signal Lever
	: PARKING LIGHT Integral with Front Turn Signal and Rear Tail Light
	: STARTER SWITCH Electric, Key Operated
	: STOP, TURN, TAIL & B/U LIGHTS Dual, Rear, Combination with Reflector
	: WINDSHIELD WIPER SWITCH 2-Speed with Wash and Intermittent Feature (5 Pre-Set Delays), Integral with Turn Signal Lever
	: WINDSHIELD WIPERS Single Motor, Electric, Cowl Mounted
8653	HORN, AIR Single, Located Under Cab
8GXJ	ALTERNATOR {Leece-Neville AV1160P2013} Brush Type, 12 Volt, 160 Amp Capacity, Pad Mount
8HAA	BODY BUILDER WIRING To Rear of Frame, with Stop, Tail, Turn, and Marker Lights Circuits, Ignition Controlled Auxiliary Feed and Ground, Less Trailer Socket
8MSG	BATTERY SYSTEM {Fleetrite} Maintenance-Free, (3) 12-Volt 1980CCA Total, Top Threaded Stud
8RBZ	SPEAKER, AUXILIARY, CB RADIO with Jack for CB; Mounted Left Side Above Driver's Door
8RMV	SPEAKERS (2) 6.5" Dual Cone Mounted in Doors
8RMX	RADIO Omit, Includes Wiring and Antenna
8RNB	CB RADIO Accommodation Package, Header Mounted, Feeds from Accessory Side of Ignition Switch, Includes Power Source, One Antenna and Antenna Base with Wiring on Left Side Mirror
8RPP	ANTENNA Shark Fin, Roof Mounted
8TNP	AUXILIARY HARNESS 5.0' for Auxiliary Front Head Lights and Turn Signals for Front Plow Applications
8VAY	HORN, ELECTRIC Disc Style
8VUK	BATTERY BOX Aluminum, with Plastic Cover, 18" Wide, 2-4 Battery Capacity, Mounted Right Side Back of Cab
8WCK	POWER SOURCE, TERMINAL TYPE 2-Post
8WEZ	TURN SIGNAL SWITCH Self-Canceling

<u>Code</u>	<u>Description</u>
8WXB	HEADLIGHT WARNING BUZZER Sounds When Head Light Switch is on and Ignition Switch is in "Off" Position
8WXG	STARTING MOTOR {Mitsubishi Electric Automotive America 105P} 12-Volt, with Soft-Start
8XAH	CIRCUIT BREAKERS Manual-Reset (Main Panel) SAE Type III with Trip Indicators, Replaces All Fuses
8XNY	HEADLIGHTS Halogen
9AAB	LOGOS EXTERIOR Model Badges
9AAE	LOGOS EXTERIOR, ENGINE Badges
9ASE	FRONT END Tilting, Composite
9HCN	GRILLE Chrome Vertical Accent Bars, with Black Mesh
10060	PAINT SCHEMATIC, PT-1 Single Color, Design 100
10761	PAINT TYPE Base Coat/Clear Coat, 1-2 Tone
10ADT	COMMUNICATIONS MODULE Telematics Device with Over the Air Programming; Includes Two Year Data Plan
10SLV	PROMOTIONAL PACKAGE Government Silver Package
10WLC	GCWR RANGE GCWR Equal to or Less than 80,000-lb, Higher GCWR May Result in Reduced Engine Performance While Operating in Extreme Hot Weather Conditions
11001	CLUTCH Omit Item (Clutch & Control)
12703	ANTI-FREEZE Red, Extended Life Coolant; To -40 Degrees F/ -40 Degrees C, Freeze Protection
12851	PTO EFFECTS, ENGINE FRONT Less PTO Unit, Includes Adapter Plate on Engine Front Mounted
12ETK	ENGINE, DIESEL {Cummins X15 430 V} Productivity Series, EPA 2021, 430HP @ 1900 RPM, 1650 lb-ft Torque @ 950 RPM, 2000 RPM Governed Speed, 441 Peak HP (Max)
12THT	FAN DRIVE {Horton Drivemaster} Two-Speed Type, Direct Drive, with Residual Torque Device for Disengaged Fan Speed <u>Includes</u> : FAN Nylon
12VCA	AIR CLEANER Single Element, with Integral Pre-Cleaner, Engine Mounted
12VHZ	EMISSION, CALENDAR YEAR {Cummins X15} EPA, OBD and GHG Certified for Calendar Year 2022
12WCX	HOSE CLAMPS, RADIATOR HOSES {Gates} Shrink Band Type
12WTA	FAN DRIVE SPECIAL EFFECTS Fan Cooling Ring with Fan Shroud Effects, Engine Mounted
12WYZ	RADIATOR DRAIN & FILL FITTING SPECIAL; To Vacuum Out or Fill the Cooling System from the Bottom of Radiator, for Use with Quick-Connect Radiator Drain Tool or Shop Coolant Evacuation-Fill System
12WZJ	CARB IDLE COMPLIANCE Low NOx Idle Engine, Complies with California Clean Air Regulations; Includes "Certified Clean Idle" Decal located on Driver Door
12XBN	RADIATOR Aluminum, Welded, Cross Flow, Front to Back System, 1084 SqliN, with 866 SqliN Charge Air Cooler <u>Includes</u> : RADIATOR HOSES Premium, Rubber
12XCP	CARB EMISSION WARR COMPLIANCE for Cummins X15 Engines Less than or Equal to 500 HP
13ATR	TRANSMISSION, AUTOMATIC {Allison 4000 RDS} 5th Generation Controls, Close Ratio, 6-Speed with Double Overdrive, with PTO Provision, Less Retarder, Includes Oil Level Sensor, On/Off Highway
13WCT	OIL COOLER, AUTO TRANSMISSION {Champ} Remote Mounted

<u>Code</u>	<u>Description</u>
13WET	TRANSMISSION SHIFT CONTROL Column Mounted Stalk Shifter, Not for Use with Allison 1000 & 2000 Series Transmission
13WLM	TRANSMISSION OIL Synthetic; 63 thru 76 Pints
13WUC	ALLISON SPARE INPUT/OUTPUT for Rugged Duty Series (RDS) and Regional Haul Series (RHS), General Purpose Trucks, Construction, Package Number 223
13WVV	NEUTRAL AT STOP Allison Transmission Shifts to Neutral When Service Brake is Depressed and Vehicle is at Stop; Remains in Neutral Until Service Brake is Released
13WYU	SHIFT CONTROL PARAMETERS {Allison} 3000 or 4000 Series Transmissions, Performance Programming
14GVL	AXLE, REAR, TANDEM {Meritor MT-40-14X-4DCR-P} Single Reduction, 40,000-lb Capacity, with Lube Oil Pump, .433"(11mm) Wall Housing Thickness, Driver Controlled Locking Differential in Forward-Rear and Rear-Rear Axle, R Wheel Ends . Gear Ratio: 4.63
14UMV	SUSPENSION, REAR, TANDEM {Hendrickson HMX EX 400} Walking Beam, 40,000-lb Capacity, 54" Axle Spacing, Rubber Springs, with Transverse Torque Rods, Rubber End Bushings
14WCR	TRANSVERSE TORQUE RODS {Hendrickson} TRAAX Rod, Transverse Only
15LKU	FUEL/WATER SEPARATOR {Racor} Fuel Pre-Filter and Filter Base, Includes Water-In-Fuel Sensor
15LNA	FUEL HEATER {Cummins} Plumbing for Thermal Recirculation Valve (TRV) Mounted to Cummins X15 Engines, Thermostatically Controlled
15SSN	FUEL TANK Non-Polished Aluminum, 24" Dia, 60 US Gal (227L), Mounted Left Side, Under Cab
15WDR	DEF TANK 10.6 US Gal (40L) Capacity, Frame Mounted Outside Left Rail, Under Cab
16030	CAB Conventional, Day Cab <u>Includes</u> : CAB REAR SUSPENSION Air : CLEARANCE/MARKER LIGHTS (5) LED Roof Mounted : COAT HOOK, CAB Located on Rear Wall, Centered Above Rear Window : CONSOLE, CENTER Includes Two Cup Holders and One Additional Storage Area : CONSOLE, OVERHEAD Molded Plastic with Dual Storage Pockets, Retainer Nets and CB Radio Pocket; Located Above Driver and Passenger : COURTESY LIGHT (2) Driver and Passenger Door Mounted : DOME LIGHT, CAB Rectangular, Door and Instrument Panel Mounted Switch Activated, Timed Theater Dimming, Center Mounted, Integral to Console : FLOOR COVERING Rubber, Black : GLASS, ALL WINDOWS Tinted : GRAB HANDLE, CAB INTERIOR (1) "A" Pillar Mounted, Passenger Side : GRAB HANDLE, CAB INTERIOR (4) "B" Pillar and Door Mounted, Two Each Side : READING LIGHT, CAB Located in Overhead Console : STORAGE POCKET, DOOR (2) Full Length, Driver and Passenger Door
16400	SEAT, PASSENGER Omit Item
16BAM	AIR CONDITIONER with Integral Heater and Defroster <u>Includes</u> : HOSE CLAMPS, HEATER HOSE Mubea Constant Tension Clamps
16GEG	GAUGE CLUSTER Premium Level; English with English Electronic Speedometer <u>Includes</u> : GAUGE CLUSTER DISPLAY: Base Level (3" Monochromatic Display), Premium Level (5" LCD Color Display); Odometer, Voltmeter, Diagnostic Messages, Gear Indicator, Trip Odometer, Total Engine Hours, Trip Hours, MPG, Distance to Empty/Refill for

<u>Code</u>	<u>Description</u>
	: GAUGE CLUSTER Speedometer, Tachometer, Engine Coolant Temp, Fuel Gauge, DEF Gauge, Oil Pressure Gauge, Primary and Secondary Air Pressure : WARNING SYSTEM Low Fuel, Low DEF, Low Oil Pressure, High Engine Coolant Temp, Low Battery Voltage (Visual and Audible), Low Air Pressure (Primary and Secondary)
16HCS	GAUGE, TEMPERATURE, AMBIENT Sensor Wiring with Display Unit Mounted in Cluster
16HKT	IP CLUSTER DISPLAY On Board Diagnostics Display of Fault Codes in Gauge Cluster
16LWK	SEAT, DRIVER {ISRI} Series 300, Air Suspension, High Back, Vinyl, Single Chamber Lumbar, Inboard Armrest, Suspension Cover, Fore/Aft Isolator, Cushion Extension, Seat Tilt
16SDC	GRAB HANDLE, EXTERIOR (2) Chrome, Towel Bar Type, with Anti-Slip Rubber Inserts, for Cab Entry Mounted Left and Right Side at B-Pillar
16SNP	MIRRORS (2) C-Loop, Power Adjust, Heated, Black Heads and Arms, 7.5" x 14" Flat Glass, Includes 7.5" x 7" Convex Mirrors, for 102" Load Width
	<u>Notes</u> : Mirror Dimensions are Rounded to the Nearest 0.5"
16VKK	CAB INTERIOR TRIM Diamond, for Day Cab
16WJU	WINDOW, POWER (2) and Power Door Locks, Left and Right Doors, Includes Express Down Feature
16XJP	INSTRUMENT PANEL Wing Panel
16XRX	MODESTY PANEL Painted
16XTM	ACCESS, CAB Aluminum, Driver & Passenger Sides, Two Steps per Door, for use with Day Cab or Sleeper Cab
27DPN	WHEELS, FRONT {Accuride 29039} DISC; 22.5x9.00 Rims, Powder Coat Steel, 5-Hand Hole, 10-Stud, 285.75mm BC, Hub-Piloted, Flanged Nut, with Steel Hubs, Non-Standard Offset, with .5" Thick Disc
28DUK	WHEELS, REAR {Accuride 29169} DUAL DISC; 22.5x8.25 Rims, Powder Coat Steel, 5-Hand Hole, 10-Stud, 285.75mm BC, Hub-Piloted, Flanged Nut, with .472" Thick Increased Capacity Disc and Steel Hubs
7372135415	(8) TIRE, REAR 11R22.5 Load Range G HSR2 (CONTINENTAL), 498 rev/mile, 75 MPH, All-Position
7772548123	(2) TIRE, FRONT 315/80R22.5 Load Range L G751 MSA (GOODYEAR), 484 rev/mile, 68 MPH, All-Position

Services Section:

40132 WARRANTY Standard for HX520, HX620, Effective with Vehicles Built January 1, 2021 or Later, CTS-2015B

Body/Allied Equipment

<u>Code</u>	<u>Description</u>
-------------	--------------------

<u>Goods Purchased</u>	<u>Description</u>
------------------------	--------------------

<u>Code</u>	<u>Description</u>
-------------	--------------------

ATTACHMENT E

DERA OPTION

2019-2020 Diesel Emissions Reduction Act (DERA) State Grants Work Plan and Budget Narrative

INSTRUCTIONS: States and territories applying for 2020 DERA State Grant funds must use this template to prepare their Work Plan and Budget Narrative.

Please refer to the 2019-2020 DERA State Grants Program Guide full program details, eligibility criteria and funding restrictions, and application instructions.

SUMMARY PAGE

Project Title: Nevada Clean Diesel Program – Early Vehicle Retirements in Nevada’s Population Centers and Electric School Bus Pilot Projects

Project Manager and Contact Information

Organization Name: Nevada Division of Environmental Protection

Project Manager: Joe Perreira (program contact) and Misti Gower (financial contact)

Mailing Address: 901 S. Stewart Street, Ste 4001
Carson City, Nevada 89701

Phone: (775) 687-9349 for Joe Perreira and (775) 687-9494 for Misti Gower

Fax: (775) 687-5856

Email: jperreira@ndep.nv.gov and mgower@ndep.nv.gov

Project Budget Overview:

	2019	2020
EPA Base Allocation	\$318,525	\$334,369
EPA Match Bonus (if applicable)	\$159,263	\$167,185
State or Territory Voluntary Matching Funds (if applicable)	\$318,525	\$334,369
Mandatory Cost-Share	\$2,407,398	\$1,150,918
Leveraged Funds	\$61,216	\$162,595
TOTAL Project Cost	\$3,264,928	\$2,149,436

Project Period

October 1, 2019 – September 30, 2023

Summary Statements

The Nevada Division of Environmental Protection (NDEP) will use FY 2019 and FY 2020 DERA funds to effectively and permanently reduce NO_x and PM_{2.5} in Clark and Washoe counties. Past DERA State Grant Program successes in Nevada are summarized online at: <https://ndep.nv.gov/air/air-pollutants/clean-diesel-program>.

FY 2019 Summary

For FY 2019, NDEP will provide pass-through funding to the Clark County School District (CCSD) and the City of Reno Municipal Service Fleet (“City of Reno” or “City”) to support the early-retirement and replacement of eleven program-eligible diesel-powered school buses and six

program-eligible diesel-powered municipal service vehicles. The selection of projects utilizing FY 2019 DERA funds is based on a statewide solicitation for projects to public fleets.

FY 2020 Summary

For FY 2020, NDEP is planning to provide pass-through funding to CCSD and the Washoe County School District (WCSD) to support the retirement of five program-eligible diesel-powered school buses and replace them with zero emission, battery electric equivalents.

SCOPE OF WORK

STATE/TERRITORY GOALS AND PRIORITIES:

The Nevada Clean Diesel Program complements state and local efforts to maintain the National Ambient Air Quality Standards (NAAQS). Areas of air quality concern within the Program area include Clark County, the Stateline area of Douglas County, the Pahrump area of Nye County, and Washoe County. Clark County is a maintenance area for PM₁₀, CO, and the 1997 O₃ standard and areas of Clark County are in nonattainment for the 2015 O₃ standard. The Stateline area of Douglas County is a maintenance area for CO. Measures are being taken in the Pahrump area of Nye County to reduce PM₁₀ levels. Washoe County is a maintenance area for CO and PM₁₀.

According to the 2014 National Emissions Inventory, diesel-based mobile source NO_x emissions accounted for more than 28.9 percent of the State's total NO_x emissions. When comparing Nevada's counties, mobile source NO_x emissions are much higher in Clark County (with Washoe County's emissions coming in second) than in the rest of the State.

VEHICLES AND TECHNOLOGIES:

FY 2019 Vehicles and Technologies

NDEP is supporting the early-retirement of eleven program-eligible diesel-powered school buses with the CCSD and the early-retirement of six program-eligible diesel-powered municipal service vehicles with the City of Reno.

CCSD's ten diesel-powered school buses are used to transport children throughout the Las Vegas Valley (specifically Hydrographic Area 212) which is in marginal nonattainment for the 2015 O₃ standard. The eleven buses selected for replacement all have a reported 2007 engine model year (the buses are 2008 vehicle model year) however CCSD has had trouble verifying this information as the engines themselves lack any kind of an engine ID tag. Figure 1 and Figure 2 below show that the vehicle ID tag of one of the buses selected for replacement has an engine serial number matching the number stamped on the engine, but there is little other information on the bus engines to verify against the documentation they have from when the buses were originally purchased. CCSD plans to photograph the engine stamps for all eleven buses selected for replacement as well as the vehicle ID tag on the buses and provide that information to NDEP before entering into a subgrant agreement with NDEP to ensure that these are the buses' original engines.

These eleven program-eligible diesel-powered school buses will all be replaced with diesel-powered school buses with engines meeting a 2016 model year or newer engine certified to EPA emission standards.

Figure 1: Vehicle ID tag from one of CCSD’s school buses selected for replacement

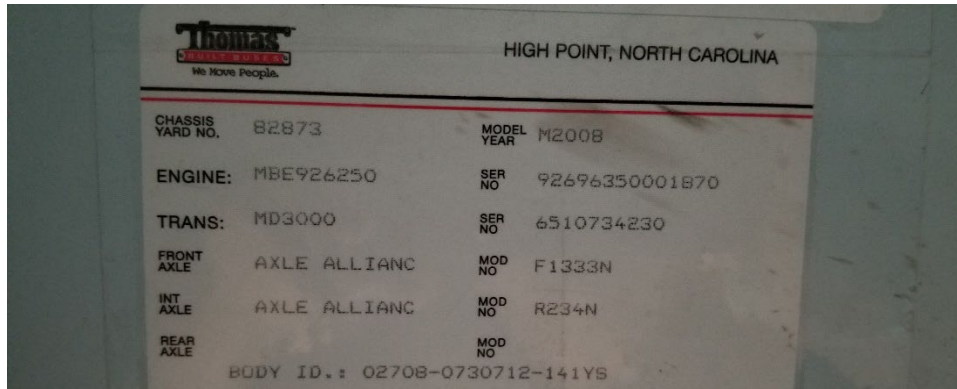
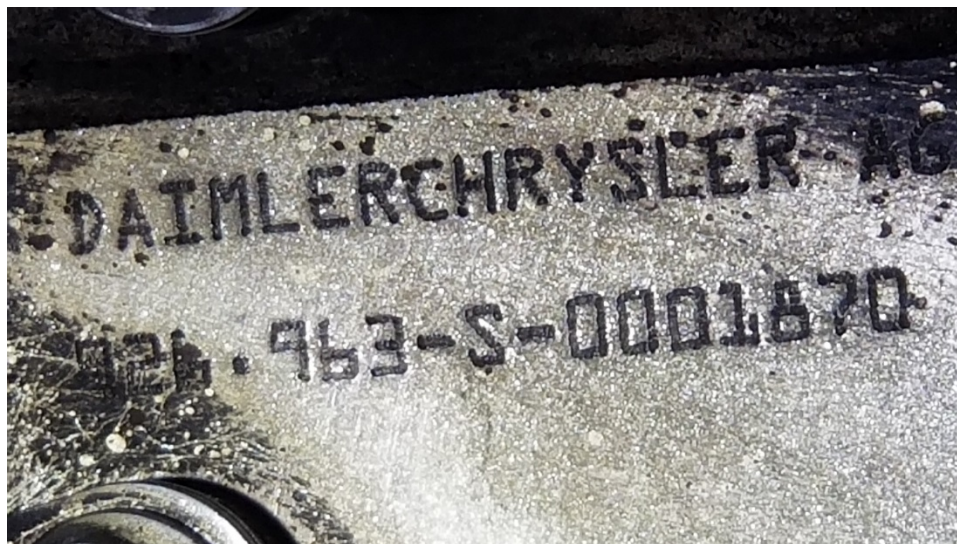

Figure 2: Engine stamp on one of CCSD’s school buses selected for replacement



The City of Reno’s six diesel-powered service vehicles operate within the Truckee Meadows (Hydrographic Area 87) and more broadly the entirety of the City of Reno to support the maintenance of roads and other critical City infrastructure. Five of the vehicles selected are combination plow/dump trucks (four of which are vehicle model year 2002/engine model year 2001 with the fifth being a 2004 vehicle and 2003 engine model year) combination plow/dump trucks and the fifth vehicle selected is a vehicle model year 2001/engine model year 2000 boom truck. These vehicles will all be replaced with diesel-powered vehicles powered by engines meeting a 2016 model year or newer engine certified to EPA emission standards.

FY 2020 Vehicles and Technologies

The NDEP is supporting the early retirement of five program-eligible diesel-powered school buses in partnership with two Nevada school districts, three with CCSD and two with WCSD. All buses will be replaced with zero emission, battery electric equivalents. While a fleet description sheet listing some of the details regarding the expected vehicle replacements has been attached with this Work Plan, the typical usage characteristics of the school buses is provided below.

The CCSD school bus fleet is primarily used to transport children throughout the Las Vegas Valley (Hydrographic Area 212) which is in marginal nonattainment for the 2015 O₃ standard (CCSD operates across all of Clark County, not just the Las Vegas Valley). The program-eligible diesel-powered school buses being proposed for early retirement and replacement by WCSD operate in the Truckee Meadows (Hydrographic Area 87) portion of Washoe County. Washoe County is a maintenance area for CO and PM₁₀ and has an O₃ design value that is on the cusp of marginal nonattainment for the 2015 O₃ NAAQS.

NDEP will ensure that both participating school districts select only program-eligible diesel-powered school buses for early retirement and that they provide some of the necessary photographic evidence (including side profile, VIN, engine serial number, and engine photos) to NDEP prior to entering into a Subgrant Agreement.

ROLES AND RESPONSIBILITIES:

FY 2019 Roles and Responsibilities

The role of the NDEP will be to act as project management and to distribute program funds to our project partners (CCSD and the City of Reno). Acting in our role as project management for FY 2019 DERA State Grant Program funds, the NDEP sent out a solicitation for projects to several dozen public fleets and school districts in Nevada looking for program-eligible projects. The NDEP has also established a listserv that public fleets and school districts in Nevada can join to stay updated on the status of funding opportunities and general information associated with the Nevada Clean Diesel Program. The NDEP received four proposals for projects this year and, of the four, the City of Reno and CCSD were selected for funding due to the vehicles proposed for early-retirement and the associated air quality benefits.

Upon approval of this Work Plan and Budget Narrative, the NDEP will develop Subgrant Agreements with our project partners which defines all the deliverables the partner must provide to the NDEP in order to receive program funds. This includes responsibilities to follow all DERA provisions and federal grant recipient requirements. Program funds are delivered on a reimbursement basis and are only delivered once the partner has demonstrated the successful replacement and scrapping of the program-eligible vehicle.

Participating fleets are required to contribute the mandatory matching funds for replacement projects. As in past program years, municipal fleets are enthusiastic community partners with a

desire to reduce emissions from their fleets. Their participation reinforces the idea to the general public that diesel emission reduction projects are practical and effective. If the estimated replacement costs of the vehicles selected for early-retirement and replacement end up being higher than the actual replacement costs, both project partners have indicated their willingness to identify additional program-eligible vehicles for early-retirement and replacement. If this ends up being the case, cost-share funds provided by the fleets above the mandatory amount will be identified as voluntary.

FY 2020 Roles and Responsibilities

The role of the NDEP will be to act as project management and once a project has been completed, to distribute program funds to our project partners (CCSD and WCSD). Acting in our role as project management for FY 2019-2020 DERA State Grant Program funds, the NDEP has been coordinating the planning for these projects with these school districts and Nevada’s primary electric utility, NV Energy.

Upon receipt of the Notice of Award, the NDEP will enter into Subgrant Agreements with our project partners that will define all the deliverables the partner must provide to the NDEP in order to receive program funds. This includes responsibilities to follow all DERA provisions and federal grant recipient requirements. Program funds are delivered on a reimbursement basis and are only delivered once the partner has demonstrated the successful replacement and scrapping of the program-eligible vehicles.

Participating fleets are required to contribute the minimum mandatory matching funds for replacement projects. As in past program years, school districts are enthusiastic community partners with a desire to reduce emissions from their fleets. Their participation reinforces the idea to the general public that diesel emission reduction projects are practical and effective. If the actual replacement costs of the vehicles selected for early-retirement and replacement end up being higher than the estimated replacement costs, our project partners have indicated their willingness to provide additional funding in order to ensure the project’s successful completion.

TIMELINE AND MILESTONES:

The following table represents a schedule of expected target dates, milestones, and completion dates to achieve specific tasks and accomplishments, during the budget and project period:

Table 1: Timelines and Milestones to Achieve Successful Project Completion

Task	Federal Fiscal Year, Quarter
NDEP begins solicitation for FY 2019 project partners	FY 2019, Quarter 3
NDEP selects FY 2019 project partners	FY 2019, Quarter 3
NDEP submits Work Plan and Budget Narrative to EPA	FY 2019, Quarter 3
EPA issues FY 2019 Notice of Award	FY 2019, Quarter 4
NDEP enters into subgrant agreements with identified FY 2019 project partners	FY 2020, Quarter 1
FY 2019 project partners begin procurement of vehicles for replacement	FY 2020, Quarter 1
NDEP begins solicitation for FY 2020 project partners	FY 2020, Quarter 1

Task	Federal Fiscal Year, Quarter
EPA Quarterly Report Due	FY 2020, Quarter 1
FY 2019 project partners provide updates to NDEP on the status of vehicle procurement and report on any delays in completing their projects	FY 2020, Quarter 2
NDEP selects FY 2020 project partners	FY 2020, Quarter 2
EPA Quarterly Report Due	FY 2020, Quarter 2
FY 2019 project partners provide updates to NDEP on the status of vehicle procurement and report on any delays in completing their projects	FY 2020, Quarter 3
FY 2019 project partners begin to receive replacement vehicles	FY 2020, Quarter 3
FY 2019 project partners begin to scrap vehicles being replaced	FY 2020, Quarter 3
NDEP submits FY 2020 Work Plan and Budget Narrative to EPA	FY 2020, Quarter 3
EPA Quarterly Report Due	FY 2020, Quarter 3
FY 2019 project partners provide updates to NDEP on the status of vehicle procurement and report on any delays in completing their projects	FY 2020, Quarter 4
FY 2019 project partners finish receiving replacement vehicles	FY 2020, Quarter 4
FY 2019 project partners complete scrappage of vehicles being replaced	FY 2020, Quarter 4
NDEP verifies evidence of scrappage provided by FY 2019 project partners and performs drawdowns to reimburse partners for successful project completion	FY 2020, Quarter 4
EPA issues FY 2020 Notice of Award	FY 2020, Quarter 4
EPA Quarterly Report Due	FY 2020, Quarter 4
FY 2020 project partners provide updates to NDEP on the status of vehicle procurement and report on any delays in completing their projects	FY 2021, Quarter 1
EPA Quarterly Report Due	FY 2021, Quarter 1
FY 2020 project partners provide updates to NDEP on the status of vehicle procurement and report on any delays in completing their projects	FY 2021, Quarter 2
EPA Quarterly Report Due	FY 2021, Quarter 2
FY 2020 project partners provide updates to NDEP on the status of vehicle procurement and report on any delays in completing their projects	FY 2021, Quarter 3
EPA Quarterly Report Due	FY 2021, Quarter 3
FY 2020 project partners begin procurement of vehicles for replacement	FY 2021, Quarter 4
EPA Quarterly Report Due	FY 2021, Quarter 4
FY 2020 project partners provide updates to NDEP on the status of vehicle procurement and report on any delays in completing their projects	FY 2022, Quarter 1
EPA Quarterly Report Due	FY 2022, Quarter 1
FY 2020 project partners provide updates to NDEP on the status of vehicle procurement and report on any delays in completing their projects	FY 2022, Quarter 2
EPA Quarterly Report Due	FY 2022, Quarter 2
FY 2020 project partners provide updates to NDEP on the status of vehicle procurement and report on any delays in completing their projects	FY 2022, Quarter 3
EPA Quarterly Report Due	FY 2022, Quarter 3
FY 2020 project partners provide updates to NDEP on the status of vehicle procurement and report on any delays in completing their projects	FY 2022, Quarter 4
EPA Quarterly Report Due	FY 2022, Quarter 4
FY 2020 project partners provide updates to NDEP on the status of vehicle procurement and report on any delays in completing their projects	FY 2023, Quarter 1
EPA Quarterly Report Due	FY 2023, Quarter 1
FY 2020 project partners begin to receive replacement vehicles	FY 2023, Quarter 2
FY 2020 project partners begin scrappage of vehicles being replaced	FY 2023, Quarter 2
NDEP identifies project partner to award remaining FY 2019 project funds	FY 2023, Quarter 2
NDEP requests and receives no-cost time extension from EPA to ensure final FY 2019 project can be completed and funded	FY 2023, Quarter 2
NDEP enters into subgrant agreement with identified FY 2019 project partner	FY 2023, Quarter 2
Remaining FY 2019 project partner begins procurement of replacement vehicle	FY 2023, Quarter 2

Task	Federal Fiscal Year, Quarter
EPA Quarterly Report Due	FY 2023, Quarter 2
Project partners provide updates to NDEP on the status of vehicle procurement and report on any delays in completing their project	FY 2023, Quarter 3
EPA Quarterly Report Due	FY 2023, Quarter 3
Project partners provide updates to NDEP on the status of vehicle procurement and report on any delays in completing their project	FY 2023, Quarter 4
FY 2020 project partners finish receiving replacement vehicles	FY 2023, Quarter 4
FY 2020 project partners complete scrappage of vehicles being replaced	FY 2023, Quarter 4
EPA Quarterly Report Due	FY 2023, Quarter 4
Remaining FY 2019 project partner provide updates to NDEP on the status of vehicle procurement and report on any delays in completing their project	FY 2024, Quarter 1
NDEP verifies evidence of scrappage provided by FY 2020 project partners and performs drawdowns to reimburse partners for successful project completion	FY 2024, Quarter 1
EPA Quarterly Report Due	FY 2024, Quarter 1
Remaining FY 2019 project partner provide updates to NDEP on the status of vehicle procurement and report on any delays in completing their project	FY 2024, Quarter 2
EPA Quarterly Report Due	FY 2024, Quarter 2
Remaining FY 2019 project partner provide updates to NDEP on the status of vehicle procurement and report on any delays in completing their project	FY 2024, Quarter 3
EPA Quarterly Report Due	FY 2024, Quarter 3
Remaining FY 2019 project partner finish receives replacement vehicle	FY 2024, Quarter 4
Remaining FY 2019 project partner complete scrappage of vehicle being replaced	FY 2024, Quarter 4
NDEP verifies evidence of scrappage provided by project partner and performs drawdowns to reimburse partner for successful project completion	FY 2024, Quarter 4
EPA Quarterly Report Due	FY 2024, Quarter 1
Final Report due to EPA	FY 2025, Quarter 1

DERA PROGRAMMATIC PRIORITIES:

The priorities of the Nevada Clean Diesel Program are aligned with the programmatic priorities of the Diesel Emissions Reduction Act of 2010, 42 USC 16131 et seq. These priorities will be met through the following:

1. The NDEP aims to build a simple, yet effective program that maximizes public health benefits for as many Nevadans as practical. The Nevada Clean Diesel Program seeks to reduce exposure to harmful diesel emissions across Nevada. Diesel emissions reductions are determined using the Diesel Emission Quantifier (DEQ) and proposals achieving significant reductions in diesel emissions in terms of tons of pollution produced and reductions in diesel emissions exposure from vehicles, engines, and equipment operating in areas designated as poor air quality areas are given priority.
2. The Nevada Clean Diesel Program is implemented through a low-overhead programmatic structure to provide assistance in increasing fleet turnover to provide quantifiable diesel emissions reductions.

3. The program focuses on public services fleets that operate their vehicles a substantial amount of time within Nevada's population centers and with public service fleets that provide services to sensitive populations.
4. This program will maximize the service life of the replacements through a Subgrant Agreement between the project partner and the NDEP. This agreement will require the recipients to maintain the equipment in compliance with the manufacturer's recommended maintenance schedule. This includes instructions on manufacturer-recommended maintenance procedures and a full explanation of the warranty provisions for the verified technologies.
5. Replacement projects will conserve diesel fuel by replacing legacy diesel vehicles with vehicles that are zero emissions or meet the most recent emission standards. Generally, the use of new technologies can reduce overall fleet diesel fuel consumption.

EPA'S STRATEGIC PLAN LINKAGE AND ANTICIPATED OUTCOMES/OUTPUTS:

EPA'S STRATEGIC PLAN LINKAGE

The program supports EPA's 2018-2022 Strategic Plan Goals. That is, the Agency's "Back-to-Basic" agenda and its three over-arching goals which reflect the Administrator's core philosophies: 1, refocus the agency back to its core mission; 2, restore power to the states through cooperative federalism; and 3, lead the agency through improved processes, and adhere to the rule of law.

FY 2019 recipient fleets will scrap early and mid-2000's engine model year diesel-powered service vehicles and school buses and replace them with new vehicles that have verified lower emissions of criteria pollutants. Reducing these pollutants protects human health and the environment in several ways. The program will help the areas of Clark County that are in nonattainment for the 2015 O₃ NAAQS get back into attainment as well as areas of Washoe County that have an O₃ design value that is on the cusp of nonattainment for the 2015 O₃ NAAQS continue to stay in attainment. Implementing this program will also help to mitigate regional air pollution.

FY 2020 partner fleets will permanently remove from service early and mid-2000's engine model year diesel-powered school buses and replace them with new, zero emissions school buses. Reducing these pollutants protects human health and the environment in several ways. The program will reduce emissions in the areas of Clark County that are in marginal nonattainment for the 2015 O₃ NAAQS and areas of Washoe County that have an O₃ design value that is on the cusp of nonattainment for the 2015 O₃ NAAQS continue to remain in attainment. Implementing this program will also help to mitigate regional air pollution.

ANTICIPATED OUTCOMES

Anticipated outcomes of the Nevada Clean Diesel Program can be expressed in short, medium, and long-term considerations. In the short-term, a broad spectrum of Nevadans, from state and local leaders, to health professionals, to environmental advocates, will recognize the value of reducing diesel emissions in our communities. The importance of reducing diesel emissions is most pronounced where vulnerable populations, such as children and the elderly, are subject to both direct and prolonged exposure to the emission source. This recognition may foster support, both programmatic and financial, on the part of groups and individuals for continued diesel emission reduction efforts. The NDEP intends to post a summary of the projects funded by FY 2019 and FY 2020 program funding and expected outcomes on the Nevada Clean Diesel Program webpage.

Medium-term outcomes are expected to include a continued reduction in fleet diesel emissions, instilling the program goals in other state and municipal fleets, and laying the groundwork for the continued replacement of other fleet vehicles.

From a long-term perspective, one expected outcome is reduced rates of certain respiratory ailments among sensitive groups in the program area. Numerous scientific studies have established a relationship between exposure to fine particulate matter (a component of diesel exhaust) and diseases such as lung cancer, asthma, pneumonia, and even heart disease. It is expected that some measurable reduction in disease rates will occur because of program implementation for those populations most at risk such as children, the elderly, and those already suffering from heart or lung disease. Additionally, there is an anticipated effect on other existing fleets to stimulate interest in further diesel emission reduction efforts. These might include retrofit programs, idle reduction efforts, or truck stop electrification and auxiliary power unit installation. The NDEP hopes that the Nevada Clean Diesel Program will continue to foster an interest among all fleets using diesel-powered vehicles in Nevada in improving air quality voluntarily through the use of retrofit technology, engine repowers, early attrition of their dirtiest vehicles, or zero emissions replacements.

ANTICIPATED OUTPUTS

FY 2019 Anticipated Outputs

Expected, measurable program outputs are quantified in two ways. The first measurable output is the number of vehicles that will be replaced. Based on the data and estimates provided by CCSD and the City of Reno, the NDEP anticipates the early retirement of 17 fleet service vehicles and school buses. Not including the mandatory cost-share (and any possible voluntary cost-share) the NDEP is awarding \$741,250 to fleets (CCSD has been awarded \$425,000 and the City has been awarded \$316,250).¹

¹ Note that these awards are preliminary and may change based on a number of factors outside of NDEP control. Final awards will be listed in subgrant agreements and will detail all programmatic requirements for project partner reimbursement.

A second output is the reduction in emissions that will result from the expected service life of the new vehicle over that of the older, replaced vehicle. The DEQ was used to calculate criteria pollutant reductions. Use of this calculation tool required that several assumptions be made concerning vehicle age, mileage, and other parameters. Results from the DEQ are in Table 3 below (a copy of the spreadsheet produced by the DEQ can be provided upon request).

A third output is the reduction in cases of respiratory illness attributable to diesel emission exposure and the associated reduction in related healthcare costs. These benefits include reduced costs associated with premature deaths, hospital visits, and time lost from work and school.

Table 2: FY 2019 Vehicle Replacement Information and Estimated Criteria Pollutant Reductions

Total Criteria Pollutant Reductions		
Pollutant	Annual Emissions (short tons)	Lifetime Emissions (short tons)
Nitrous Oxides (NO_x)	1.2842	3.4838
Particulate Matter (PM_{2.5})	0.0605	0.0794
Hydrocarbons (HC)	0.1005	0.1883
Carbon Monoxide (CO)	0.4268	0.7362
Carbon Dioxide (CO₂)	0	0

Project #1 – Diesel-Powered School Bus Replacements	Vehicle Class/Equipment	School Buses
	Number of Vehicles	11
	Model Year	2007
Pollutant	Annual Emissions (short tons)	Lifetime Emissions (short tons)
Nitrous Oxides (NO _x)	0.4203	2.5216
Particulate Matter (PM _{2.5})	0.0017	0.0097
Hydrocarbons (HC)	0.0153	0.0917
Carbon Monoxide (CO)	0.0578	0.3463
Carbon Dioxide (CO ₂)	0	0

Project #2a – Diesel-Powered Service Vehicle Replacements	Vehicle Class/Equipment	Class 8 Service Vehicles
	Number of Vehicles	4
	Model Year	2001
Pollutant	Annual Emissions (short tons)	Lifetime Emissions (short tons)
Nitrous Oxides (NO _x)	0.6549	0.6549
Particulate Matter (PM _{2.5})	0.0397	0.0397
Hydrocarbons (HC)	0.0498	0.0498
Carbon Monoxide (CO)	0.2877	0.2877
Carbon Dioxide (CO ₂)	0	0

Project #2b – Diesel-Powered Service Vehicle Replacement	Vehicle Class/Equipment	Class 6 Service Vehicle
	Number of Vehicles	1
	Model Year	2000
Pollutant	Annual Emissions (short tons)	Lifetime Emissions (short tons)
Nitrous Oxides (NO _x)	0.1108	0.1108
Particulate Matter (PM _{2.5})	0.0083	0.0083
Hydrocarbons (HC)	0.0242	0.0242
Carbon Monoxide (CO)	0.0605	0.0605
Carbon Dioxide (CO ₂)	0	0

Project #2c – Diesel-Powered Service Vehicle Replacement	Vehicle Class/Equipment	Class 8 Service Vehicle
	Number of Vehicles	1
	Model Year	2003
Pollutant	Annual Emissions (short tons)	Lifetime Emissions (short tons)
Nitrous Oxides (NO _x)	0.0982	0.1964
Particulate Matter (PM _{2.5})	0.0108	0.0217
Hydrocarbons (HC)	0.0113	0.0225
Carbon Monoxide (CO)	0.0208	0.0417
Carbon Dioxide (CO ₂)	0	0

Default values from the DEQ were used for quantifying the emissions reductions of the vehicle replacements (assumed an upgrade year of 2020 for projects 1, 2a, and 2b and an upgrade year of 2023 for project 2c). A more accurate idea of expected emissions reductions will be calculated

when CCSD and the City of Reno have submitted actual vehicle data to the NDEP. Of the default values used in the DEQ, the NDEP is certain that remaining vehicle life and idling hours for the City of Reno service vehicles will increase. These vehicles were selected for their long periods of idling and because the City has had to rethink their fleet replacement schedule. The City has provided a memo to the NDEP (included with this Work Plan as an attachment) that details their reasoning behind having to continue to extend vehicle life due to continued budget shortfalls that prevent them from following their internal replacement schedule.

FY 2020 Anticipated Outputs

Expected, measurable program outputs are quantified in two ways. The first measurable output is the number of vehicles that will be replaced. Based on the data and estimates provided by our partner school districts, the NDEP anticipates the early retirement of five school buses. Not including the mandatory cost-share (and any possible additional leveraged funds) the NDEP is awarding \$779,065.00 to fleets.

A second output is the reduction in emissions that will result from the expected service life of the new vehicle over that of the older, replaced vehicle. The Diesel Emissions Quantifier (DEQ) was used to calculate criteria pollutant reductions. Use of this calculation tool required that several assumptions be made concerning vehicle age, mileage, and other parameters. Results from the DEQ are in Table 4 below (a copy of the spreadsheet produced by the DEQ can be provided upon request).

Table 3: FY 2020 Vehicle Replacement Information and Estimated Criteria Pollutant Reductions

Total Criteria Pollutant Reductions		
Pollutant	Annual Emissions (short tons)	Lifetime Emissions (short tons)
Nitrous Oxides (NO_x)	0.3961	1.5457
Particulate Matter (PM_{2.5})	0.0185	0.0898
Hydrocarbons (HC)	0.0571	0.2629
Carbon Monoxide (CO)	0.1467	0.6476
Carbon Dioxide (CO₂)	76.041	243.882

Project #1 – CCSD Diesel-Powered School Bus Replacement	Vehicle Class/Equipment	School Buses
	Number of Vehicles	3
	Model Year	2007
	Estimated Remaining Useful Life	2 years
Pollutant	Annual Reduction (short tons)	Lifetime Reduction (short tons)
NO _x	0.1449	0.2898
PM _{2.5}	0.0009	0.0018
HC	0.0075	0.015
CO	0.0285	0.0567
CO ₂	45.441	90.882

Project #2 – WCSD Diesel-Powered School Bus Replacements	Vehicle Class/Equipment	School Buses
	Number of Vehicles	2
	Model Year	2002
	Estimated Remaining Useful Life	5 years
Pollutant	Annual Reduction (short tons)	Lifetime Reduction (short tons)
NO _x	0.2512	1.2559
PM _{2.5}	0.0176	0.088
HC	0.0496	0.2479
CO	0.1182	0.5909
CO ₂	30.6	153

Default values from the DEQ were used for quantifying the emissions reductions of the vehicle replacements (assumed an upgrade year of 2021). A more accurate idea of expected emissions reductions will be calculated when CCSD and WCSD have provided actual vehicle usage data to the NDEP.

A third output is the reduction in cases of respiratory illness attributable to diesel emission exposure and the associated reduction in related healthcare costs. These benefits include reduced costs associated with premature deaths, hospital visits, and time lost from work and school.

SUSTAINABILITY OF THE PROGRAM:

The Nevada Clean Diesel Program has been actively involved in supporting diesel-emission reduction solutions to state and municipal fleets in Nevada for more than a decade and shows no signs of slowing down. The NDEP actively promotes program successes, provides assistance to fleets (both public and private) in finding ways to reduce diesel emissions in their fleets, and attends conferences to both spread awareness about the Program’s efforts and to learn more about cost-effective solutions to mitigating diesel emissions and transitioning Nevada’s fleet of diesel-powered vehicles to zero- and near zero-emission solutions.

BUDGET NARRATIVE

FY 2019-2020 Itemized Project Budget – Anticipated

This anticipated itemized project budget was originally submitted with the approved FY 2020 Work Plan and Budget Narrative

Budget Category	FY 2019				FY 2020					Line Total
	EPA Allocation	Mandatory Cost-Share	Voluntary Match - VW Mitigation Trust Funds	FY 2019 Line Sub-Total	EPA Allocation	Mandatory Cost-Share	Voluntary Match - VW Mitigation Trust Funds	Additional Leveraged Funds	FY 2020 Line Sub-Total	
1. Personnel	\$32,011.00			\$32,011.00	\$33,122.00				\$33,122.00	\$65,133.00
2. Fringe Benefits	\$12,795.00			\$12,795.00	\$13,186.00				\$13,186.00	\$25,981.00
3. Travel										
4. Equipment										
5. Supplies										
6. Contractual										
7. Other	\$422,725.00	\$2,223,750.00	\$318,525.00	\$2,965,000.00	\$444,697.00	\$1,148,675.00	\$334,369.00	\$160,759.00	\$2,088,500.00	\$5,053,500.00
8. Total Direct Charges (sum 1-7)	\$467,531.00	\$2,223,750.00	\$318,525.00	\$3,009,806.00	\$491,005.00	\$1,148,675.00	\$334,369.00	\$160,759.00	\$2,134,808.00	\$5,144,614.00
9. Indirect Charges	\$10,257.00			\$10,257.00	\$10,549.00				\$10,549.00	\$20,806.00
10. Total (Indirect + Direct)	\$477,788.00	\$2,223,750.00	\$318,525.00	\$3,020,063.00	\$501,554.00	\$1,148,675.00	\$334,369.00	\$160,759.00	\$2,145,357.00	\$5,165,420.00
11. Program Income										

FY 2019-2020 Itemized Project Budget – Actual

This actual itemized project budget is being submitted to illustrate actual project costs as they have occurred to date and those project costs that are still anticipated to occur.

Budget Category	FY 2019					FY 2020					Line Total
	EPA Allocation	Mandatory Cost-Share	Voluntary Match - VW Mitigation Trust Funds	Additional Leveraged Funds	FY 2019 Line Sub-Total	EPA Allocation	Mandatory Cost-Share	Voluntary Match - VW Mitigation Trust Funds	Additional Leveraged Funds	FY 2020 Line Sub-Total	
1. Personnel	\$32,011.00				\$32,011.00	\$33,123.00				\$33,123.00	\$65,134.00
2. Fringe Benefits	\$12,795.00				\$12,795.00	\$13,186.00				\$13,186.00	\$25,981.00
3. Travel											
4. Equipment											
5. Supplies											
6. Contractual											
7. Other	\$422,725.00	\$2,407,398.44	\$318,525.00	\$61,216.54	\$3,209,864.89	\$444,696.00	\$1,150,918.04	\$334,369.00	\$162,595.21	\$2,092,578.25	\$5,302,443.14
8. Total Direct Charges (sum 1-7)	\$467,531.00	\$2,407,398.44	\$318,525.00	\$61,216.54	\$3,254,670.89	\$491,005.00	\$1,150,918.04	\$334,369.00	\$162,595.21	\$2,138,887.25	\$5,393,558.14
9. Indirect Charges	\$10,257.00				\$10,257.00	\$10,549.00				\$10,549.00	\$20,806.00
10. Total (Indirect + Direct)	\$477,788.00	\$2,407,398.44	\$318,525.00	\$61,216.54	\$3,264,927.89	\$501,554.00	\$1,150,918.04	\$334,369.00	\$162,595.21	\$2,149,436.25	\$5,414,364.14
11. Program Income											

Explanation of Budget Framework

FY 2019 Explanation of Budget Framework

Personnel - List all staff positions by title. Give annual salary, percentage of time assigned to the project, and total cost for the budget period.

Title	Annual Salary	Percent Time Commitment to Project	Total Cost to Budget
Chief, Bureau of Air Quality Planning	\$87,700	9%	\$7,893
Management Analyst 1	\$43,395	10%	\$4,539
Supervisor, Environmental Scientist 4	\$74,420	10%	\$7,424
Staff 2, Associate Engineer	\$67,451	18%	\$12,154
Personnel Total			\$32,011

Fringe Benefits - Identify the percentage used, the basis for its computation, and the types of benefits included.

Title	Annual Salary	Annual Fringe Benefits	Fringe Benefit Percent	Percent Time Commitment to Project	Total Cost to Budget
Chief, Bureau of Air Quality Planning	\$87,700.00	\$27,522	31%	9%	\$2,476.98
Management Analyst 1	\$43,395.00	\$25,556	56%	10%	\$2,555.60
Supervisor, Environmental Scientist 4	\$74,420.00	\$35,268	48%	10%	\$3,526.80
Staff 2, Associate Engineer	\$67,451	\$23,529	35%	18%	\$4,235.22
Fringe Total					\$12,795

Fringe benefits are from the expected NDEP budget for state FY 2020. The percentages vary based on the benefits allocation as established by the State of Nevada Department of Administration (hr.nv.gov).

Travel - Specify the mileage, per diem, estimated number of trips in-State and out-of-State, number of travelers, and other costs for each type of travel.

No travel costs have been budgeted.

Supplies - "Supplies" means all tangible personal property other than "equipment".

No supply costs have been budgeted.

Equipment - Identify each item to be purchased which has an estimated acquisition cost of \$5,000 or more per unit and a useful life of more than one year.

No equipment costs have been budgeted.

Contractual - Identify each proposed contract and specify its purpose and estimated cost.

No contractual costs have been budgeted.

Other - List each item in sufficient detail for EPA to determine the reasonableness and allowability of its cost.

Line Item and Itemized Cost	Federal Funds	Voluntary State Match (paid by Nevada)	Mandatory Cost-Share (paid by fleet owner)	Additional Leveraged Funds (paid by fleet owner)	Total Project Cost
Project #1 – CCSD Diesel-Powered School Bus Replacements					
Vehicle 1	\$22,033.80	\$16,602.56	\$125,811.84	\$3,300.95	\$167,749.25
Vehicle 2	\$22,033.80	\$16,602.56	\$125,811.84	\$3,300.95	\$167,749.25
Vehicle 3	\$22,033.80	\$16,602.56	\$125,811.84	\$3,300.95	\$167,749.25
Vehicle 4	\$22,033.80	\$16,602.56	\$125,811.84	\$3,300.95	\$167,749.25
Vehicle 5	\$22,033.80	\$16,602.56	\$125,811.84	\$3,300.95	\$167,749.25
Vehicle 6	\$22,033.80	\$16,602.56	\$125,811.84	\$3,300.95	\$167,749.25
Vehicle 7	\$22,033.80	\$16,602.56	\$125,811.84	\$3,300.95	\$167,749.25
Vehicle 8	\$22,033.80	\$16,602.56	\$125,811.84	\$3,300.95	\$167,749.25
Vehicle 9	\$22,033.80	\$16,602.56	\$125,811.84	\$3,300.95	\$167,749.25
Vehicle 10	\$22,033.80	\$16,602.56	\$125,811.84	\$3,300.95	\$167,749.25
Vehicle 11	\$22,033.80	\$16,602.56	\$125,811.84	\$3,300.95	\$167,749.25
Project #1 Subtotal	\$242,371.80	\$182,628.16	\$1,383,931.24	\$36,310.45	\$1,845,240.65

Project #2 – City of Reno Diesel-Powered Service Vehicle Replacements					
Vehicle 1	\$36,042.14	\$24,028.10	\$180,210.70	\$0.00	\$240,280.94
Vehicle 2	\$36,042.14	\$24,028.10	\$180,210.70	\$0.00	\$240,280.94
Vehicle 3	\$36,042.14	\$24,028.10	\$180,210.70	\$0.00	\$240,280.94
Vehicle 4	\$36,042.14	\$24,028.10	\$180,210.70	\$0.00	\$240,280.94
Vehicle 5	\$18,682.82	\$12,455.22	\$93,414.21	\$0.00	\$124,552.25
Vehicle 6	\$17,501.82	\$27,329.22	\$209,211.19	\$24,906.00	\$278,948.23
Project #2 Subtotal	\$180,353.20	\$135,896.84	\$1,023,468.20	\$24,906.00	\$1,364,624.24

Other Total	\$422,725.00	\$318,525.00	\$2,223,750.00	\$61,216.45	\$3,209,864.89
--------------------	---------------------	---------------------	-----------------------	--------------------	-----------------------

Indirect Charges - If indirect charges are budgeted, indicate the approved rate and base.

Title	Annual Salary Plus Fringe	Indirect Rate	Percent Time Commitment to Project	Total Cost to Budget
Chief, Bureau of Air Quality Planning	\$115,222	22.9%	9%	\$2,374.73
Management Analyst 1	\$70,951	22.9%	10%	\$1,624.78
Supervisor, Environmental Scientist 4	\$109,508	22.9%	10%	\$2,507.73
Staff 2, Associate Engineer	\$90,980	22.9%	18%	\$3,750.20
Indirect Total				\$10,257

The NDEP has submitted to the EPA a request for an Indirect Cost Rate of 22.9 percent for state FY 2020, which is the rate used in this application.

FY 2020 Explanation of Budget Framework

Personnel - List all staff positions by title. Give annual salary, percentage of time assigned to the project, and total cost for the budget period.

Title	Annual Salary	Percent Time Commitment to Project	Total Cost to Budget
Chief, Bureau of Air Quality Planning	\$91,852.00	9%	\$8,267.00
Management Analyst 1	\$47,411.00	10%	\$4,741.00
Supervisor, Environmental Scientist 4	\$74,240.00	10%	\$7,424.00
Staff 2, Associate Engineer	\$70,502.00	18%	\$12,691.00
Personnel Total			\$33,123.00

Fringe Benefits - Identify the percentage used, the basis for its computation, and the types of benefits included.

Title	Annual Fringe Benefits	Percent Time Commitment to Project	Total Cost to Budget
Chief, Bureau of Air Quality Planning	\$28,603.00	9%	\$2,574.00
Management Analyst 1	\$26,551.00	10%	\$2,655.00
Supervisor, Environmental Scientist 4	\$35,547.00	10%	\$3,555.00
Staff 2, Associate Engineer	\$24,457.00	18%	\$4,402.00
Fringe Total			\$13,186.00

Travel - Specify the mileage, per diem, estimated number of trips in-State and out-of-State, number of travelers, and other costs for each type of travel.

No travel costs have been budgeted.

Supplies - "Supplies" means all tangible personal property other than "equipment".

No supply costs have been budgeted.

Equipment - Identify each item to be purchased which has an estimated acquisition cost of \$5,000 or more per unit and a useful life of more than one year.

No equipment costs have been budgeted.

Contractual - Identify each proposed contract and specify its purpose and estimated cost.

No contractual costs have been budgeted.

Other - List each item in sufficient detail for EPA to determine the reasonableness and allowability of its cost.

All program-eligible vehicle purchases listed in the table below are through sub-awards to our partner school districts.

Line Item and Itemized Cost	Federal Funds	Voluntary State Match (paid by Nevada)	Mandatory Cost-Share (paid by fleet owner)	Additional Leveraged Funds	Total Project Cost
Project #1 – CCSD Diesel-Powered School Bus Replacement					
Vehicle 1	\$88,939.20	\$66,873.80	\$219,983.91	\$24,173.84	\$399,970.75
Vehicle 2	\$88,939.20	\$66,873.80	\$219,983.91	\$24,173.84	\$399,970.75
Vehicle 3	\$88,939.20	\$66,873.80	\$219,983.91	\$24,173.84	\$399,970.75
Project #1 Subtotal	\$266,817.60	\$200,621.40	\$659,951.74	\$72,521.51	\$1,199,912.25
Project #2 – WCSD Diesel-Powered School Bus Replacements					
Vehicle 1	\$88,939.20	\$66,873.80	\$245,483.15	\$45,036.85	\$446,333.00
Vehicle 2	\$88,939.20	\$66,873.80	\$245,483.15	\$45,036.85	\$446,333.00
Project #2 Subtotal	\$177,878.40	\$133,747.60	\$490,966.30	\$90,073.70	\$892,666.00
Other Total	\$444,696.00	\$334,369.00	\$1,150,918.04	\$162,595.21	\$2,092,578.25

Indirect Charges - If indirect charges are budgeted, indicate the approved rate and base.

Title	Annual Salary Plus Fringe	Indirect Rate	Percent Time Commitment to Project	Total Cost to Budget
Chief, Bureau of Air Quality Planning	\$120,455	22.78%	9%	\$2,469.57
Management Analyst 1	\$73,962	22.78%	10%	\$1,684.85
Supervisor, Environmental Scientist 4	\$109,787	22.78%	10%	\$2,500.95
Staff 2, Associate Engineer	\$94,959	22.78%	18%	\$3,893.70
Indirect Total				\$10,549

The NDEP has submitted to the EPA a request for an Indirect Cost Rate of 22.78 percent for state FY 2021, which is the rate used in this application.

Administrative Costs Expense Cap

FY 2019 Administrative Costs

The NDEP has budgeted \$55,050 from this program year to cover administrative expenses. These funds will go to covering personnel, fringe, and indirect costs associated with successfully executing the program. The proposed personnel and fringe benefit costs total \$44,806, which is 5.6 percent of the total project cost (total project cost includes the federal share as well as Nevada's voluntary cost-share)

FY 2020 Administrative Costs

The NDEP has budgeted \$56,857 from this program year to cover administrative expenses. These funds will go to covering personnel, fringe, and indirect costs associated with successfully executing the program. The proposed personnel and fringe benefit costs total \$46,308, which is 2.16 percent of the total project cost (total project cost includes the federal share as well as Nevada's voluntary cost-share).

Matching Funds and Cost-Share Funds

FY 2019 Matching and Cost-Share Funds

The NDEP intends to use funds from the Volkswagen Environmental Mitigation Trust Fund for State Beneficiaries (State Trust) to meet the Program voluntary match. Nevada has already submitted and received approval on multiple funding requests to Wilmington Trust (the Trustee managing the State Trust) relating directly to DERA State Grant Program projects (see <https://www.vwenvironmentalmitigationtrust.com/state-trust/nevada> for more information). CCSD and the City of Reno will both be meeting their mandatory cost-shares through their fleet replacement budgets. They will not be using any additional federal or State Trust funds to support the purchases of these vehicles.

FY 2020 Matching and Cost-Share Funds

The NDEP intends to use funds from the Volkswagen Environmental Mitigation Trust Fund for State Beneficiaries (State Trust) to meet the Program voluntary match. Nevada has already submitted and received approval on multiple funding requests to Wilmington Trust (the Trustee managing the State Trust) relating directly to DERA State Grant Program projects (see <https://www.vwenvironmentalmitigationtrust.com/state-trust/nevada> for more information). The school districts will be meeting their mandatory cost-shares through a partnership with NV Energy, which will be using a ratepayer-funded program to support the funding of these fleet replacements (more information regarding NV Energy's Electric Vehicle Custom Grant Program can be found on their website, <https://www.nvenergy.com/cleanenergy/electric-vehicles>). The partner school districts will not be using any additional federal monies or State Trust funds to support the purchases of these vehicles.

Funding Partnerships

FY 2019 Funding Partnerships

The NDEP will enter into subgrant agreements with both CCSD and the City of Reno. These agreements will only fund vehicle replacement costs. Also, the Nevada Clean Diesel Program is operated on a reimbursement basis and subgrantees will not be reimbursed until and unless they provide sufficient evidence of vehicle scrappage and project completion to the NDEP.

FY 2020 Funding Partnerships

The NDEP will enter into subgrant agreements with CCSD and WCSD. These agreements will only fund vehicle replacement costs. Also, the Nevada Clean Diesel Program is operated on a reimbursement basis and subgrantees will not be reimbursed until and unless they provide sufficient evidence of vehicle scrappage and project completion to the NDEP.

Other Leveraged Funds

There are no other leveraged funds that will be collected at this time. If, through scrapping their vehicles, our project partners generate program revenue, that revenue will be directly applied to covering their mandatory cost-share and will be recorded in the final report.

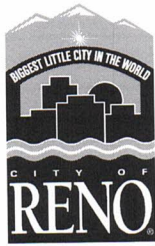

PUBLIC WORKS DEPARTMENT

MEMORANDUM

DATE: May 21, 2019
TO: Joe Perreira, Staff Engineer
FROM: Zac Haffner, Maintenance & Operations Manager 
SUBJECT: Fleet replacement schedule – 2002 Snow Plows

The City of Reno (COR) has struggled to fund the established Vehicular Equipment Replacement Schedule (RS) as outlined in its internal service fund policy #610 since the recession of the late 2000's. That policy calls for equipment to be replaced based off of an established service life for the different classes of vehicles that the city operates. The service life of many classes of vehicles/equipment were extended with a change to the RS that took effect 12/1/13 to better mirror longevity being had as well as to help with the shortfall in budget.

Each year that the replacement funding is short to the Fleet Management Fund, replacements are being delayed and/or fall behind other pieces of equipment that may have a higher use. Fleet Management has had to prioritize replacements based off of more than the service life replacement schedule alone, and that includes reviewing mileage or engine hours, departmental needs, age, condition, life-to-date costs, utilization, obsolescence, and funding. The shortfall in funding each year causes the annual request for replacements to be increased.

In FY18, Fleet Management noticed the numbers being requested were not going to be funded, and took a new approach of request. A detailed look was given to all equipment within the fleet and a 5-year catch up replacement schedule was discussed with the budget office. The plan adjusted replacements dates of all the equipment in the fleet. Fleet Management helped to fund the first year of the 5-year catch up plan by reducing reserves and its fuel budget. Unfortunately, Fleet Management was just made aware that the 5-year catch up plan will be short funds in year 2 of the mentioned plan.

This continual shortfall causes the service lives to be extended year after year. For example, the current snow plow (#220604) that is scheduled to be replaced working with the Nevada Division of Environmental Protection would have had its service life extended had it not been for the grant awarded through the Nevada State Clean Diesel Program.

Although the majority of the city's fleet is past its scheduled service life per the RS, each year service lives are extended due to the ongoing budget shortfalls. This is the case for the requested 2002 snow plows that are being proposed for replacement. The city is committing to early replacement of these four 2002 snow plows if grant funding can be obtained through the Nevada Clean Diesel Program.